

MAGIC

M2/M2+/B2/B2+**M1/B1**

Type: SUP061A

Type: SUP061C

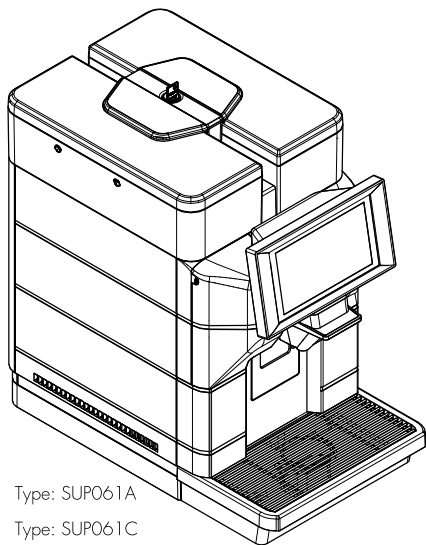
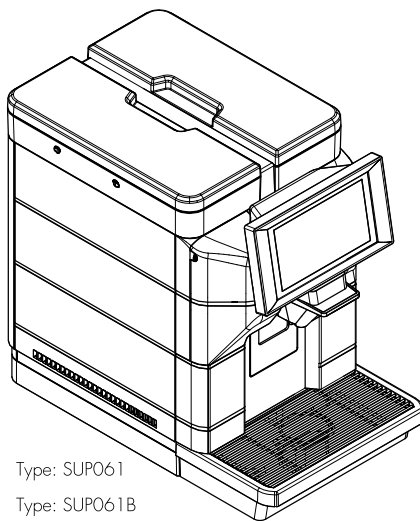

Type: SUP061

Type: SUP061B

OPERATION AND MAINTENANCE

MAIN PARTS

MAIN PARTS VERSION M2/B2

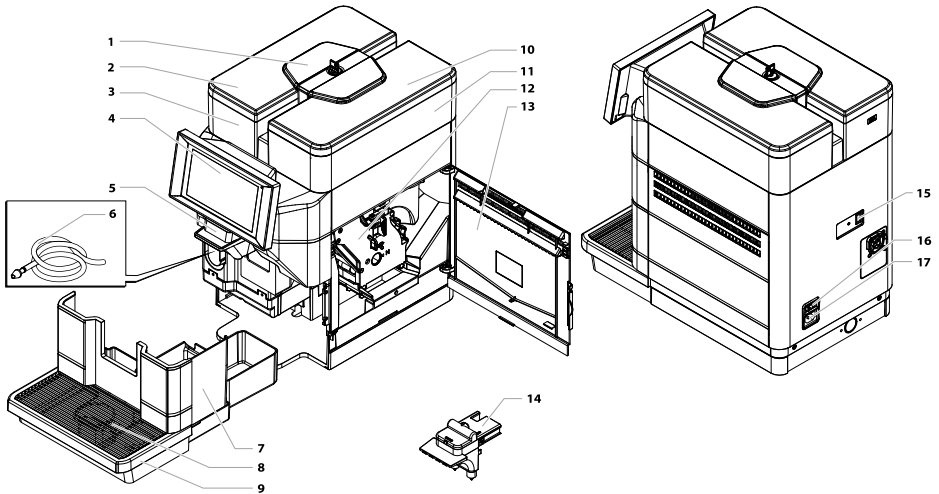

1	Tank lid with lock
2	Water tank lid
3	Water tank
4	Touch Screen Control Panel
5	Mobile dispenser
6	Suction tube for Cappuccino maker (*only M2 version)
7	Coffee grounds drawer
8	Cup holder grill
9	Drip tray

10	Coffee bean hopper lid
11	Coffee bean hopper
12	Brew group
13	Service door
14	Cappuccino maker (*only M2 version)
15	USB port
16	Power button
17	Chassis plug

MAIN PARTS VERSION M2+/B2+

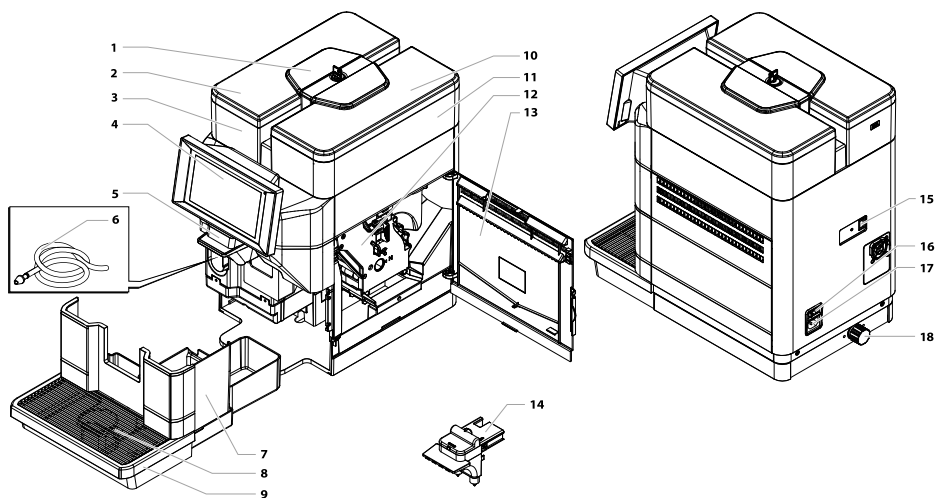

1	Tank lid with lock
2	Water tank lid
3	Water tank
4	Touch Screen Control Panel
5	Mobile dispenser
6	Suction tube for Cappuccino maker (*only M2+ version)
7	Coffee grounds drawer
8	Cup holder grill
9	Drip tray

10	Coffee bean hopper lid
11	Coffee bean hopper
12	Brew group
13	Service door
14	Cappuccino maker (*only M2+ version)
15	USB port
16	Power button
17	Chassis plug
18	Water connection coupling



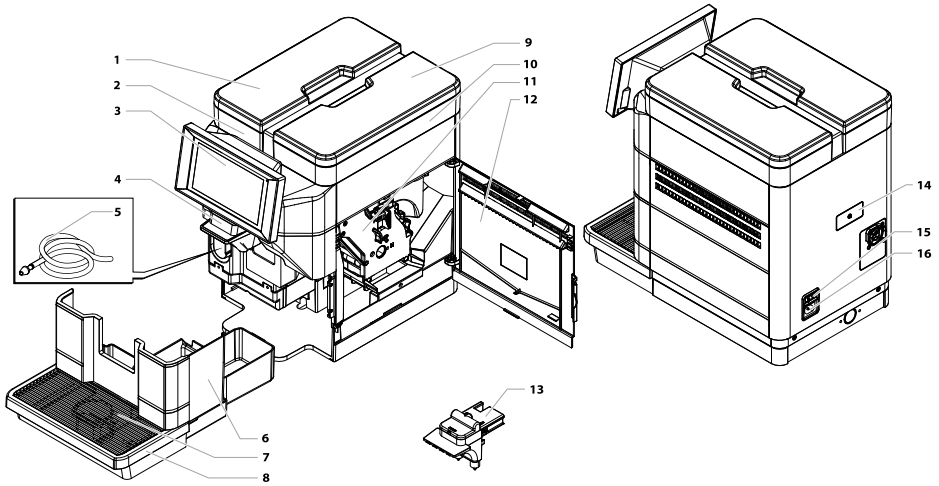





MAIN PARTS VERSION M1/B1



1	Water tank lid
2	Water tank
3	Touch Screen Control Panel
4	Mobile dispenser
5	Suction tube for Cappuccino maker (*only M1 version)
6	Coffee grounds drawer
7	Cup holder grill
8	Drip tray

9	Coffee bean hopper lid
10	Coffee bean hopper
11	Brew group
12	Service door
13	Cappuccino maker (*only M1 version)
14	USB port
15	Power button
16	Chassis plug

SAFETY INSTRUCTIONS

-  **Never allow water to come into contact with any of the electrical parts of the machine: danger of short circuit! Hot water and steam may cause scalding!**
-  Children must not play with the appliance.
-  Children cannot clean or service the machine out of supervision of an adult.
-  **Intended Use**
-  The machine is intended to be used in small offices/organisations only.
-  The machine may be used by children older than 8 or by persons with reduced physical, mental or sensory abilities or lacking sufficient experience and/or skills, provided that they are supervised or instructed on how to use the appliance correctly and understand the hazards involved.
-  **Water connection (*only versions M2+ and B2+).**
-  Before connecting the appliance to the water mains, please read and follow the applicable regulations in force in your country.
-  Connect the appliance to a drinking water distribution pipe with pressure between 0.15 MPa and 0.8 MPa (1.5 and 8 bar), see data on the label.

Power Supply

 The machine must be connected to the power supply by the service provider, in accordance with its specifications.

Power cord

 Never use power defective cords.

 Report any defects in the cord and/or plug to the service provider immediately.

 Do not pass the power cord around corners, over sharp edges or over hot objects and keep it away from oil.

 Do not use the power cord to carry or pull the machine. Do not pull out the plug by the power cord or touch it with wet hands or feet. Do not let the power cord hang freely from tables or shelves.

Safety of Persons

 Ensure that children cannot play with the machine and/or the packaging materials.

 Never direct the jet of hot water and/or steam towards yourself or others.

 Do not touch the hot water wand with bare hands. Always use the handles or knobs provided.

Danger of Burning

 Do not touch the hot water wand and/or the coffee/beverage dispensing spout.

Fire Safety Precautions

 In case of fire, use carbon dioxide (CO₂) extinguishers. Do not use water or dry powder extinguishers.

⚠️ Suitable Location for Operation and Maintenance

⚠️ The machine should be installed by the service provider in accordance with the safety regulations in force at the time of installation.

⚠️ The machine may only be moved by the service provider.

⚠️ Do not use the machine outdoors.

⚠️ Do not install the machine in a location where water jets may be used.

⚠️ Do not use open flames and/or incandescent objects near the machine so as not to damage or melt the machine housing.

⚠️ The appliance must be installed on a horizontal surface.

⚠️ Do not use the coffee machine in an environment with temperature values lower and/or equal to 2°C or higher than 32°C; If the machine has been exposed to such conditions, alert the service provider, who will carry out a safety check.

⚠️ The machine must only be installed in places where it can be checked by qualified staff.

⚠️ Cleaning the machine

⚠️ Before cleaning the machine, switch OFF (0) the power button and the remove the plug from the power socket. Wait for the machine to cool down.

⚠️ Never immerse the machine in water!

⚠️ It is strictly forbidden to tamper with the internal parts of the machine.

⚠ Do not clean the machine using jets of water.

⚠ The appliance and its parts should be cleaned and washed following a period of inactivity.

⚠ **Using Milk (*only versions M).**

⚠ Milk must be used and stored in accordance with the instructions given on the manufacturer's original packaging.

⚠ We accept no liability for use of milk unsuitable for human consumption.

⚠ Milk must be kept cold, as high temperatures will make it turn sour - this is a natural characteristic of milk. For this reason, the Cappuccinatore must be cleaned after each use, as described in the manual.

⚠ **Storing the Machine**

⚠ When the machine will not be used for a long period of time, turn it off and unplug it from the outlet.

⚠ Store the machine in a dry place, out of the reach of children. Keep it protected from dust and dirt.

⚠ Before storing the machine for a medium long period of time, we recommend rinsing the coffee circuit once/twice.

⚠ **Servicing / Maintenance**

⚠ In case of failures, defects or suspected faults resulting from a fall, immediately unplug the machine from power socket and alert the service provider or specialised technician.

⚠ Never attempt to operate the machine if it is faulty.

 Only the service provider and/or technician may service or repair the machine.

 Only skilled and experienced people - with particular reference to safety and hygiene - are allowed to access the service area.

CONTENTS

1 INTRODUCTION TO THE MANUAL... 11	
1.1 Preamble.....	11
1.2 Icons Used.....	11
2 INFORMATION ABOUT THE..... 13	
APPLIANCE..... 13	
2.1 Information for the Maintenance Technician.....	13
2.2 Description and Intended Use.....	13
2.3 Appliance Identification.....	14
2.4 Technical Data - version M2 and B2.....	15
2.5 Technical Data - version M2+ and B2+.....	16
2.6 Technical Data - version M1 and B1.....	17
3 SAFETY..... 18	
3.1 Preamble.....	18
3.2 General Safety Instructions.....	18
3.3 Operator Requirements.....	19
3.4 Residual Risks.....	19
4 HANDLING AND STORAGE..... 20	
4.1 Unloading and Handling.....	20
4.2 Storage.....	20
5 INSTALLATION..... 21	
5.1 Cautions.....	21
5.2 Unpacking and Positioning.....	22
5.3 Connection and setting for the water mains.....	24
5.4 Connection to the Electric Network.....	27
6 DESCRIPTION OF CONTROLS..... 28	
6.1 Power button.....	28
6.2 Touch Screen Control Panel.....	28
6.3 Operating in normal user mode.....	29
7 SUPPLY AND START UP..... 30	
7.1 Opening the Upper Lid.....	30
7.2 Coffee Blends.....	30
7.3 Coffee Bean Supply.....	30
7.4 Filling the Water Tank.....	31
7.5 Measuring and Adjusting Water Hardness.....	32
7.6 Water filter.....	33
7.7 Closing the Upper Lid.....	35
7.8 Coffee Grind Adjustment.....	35
7.9 Adjusting the "Aroma" - Amount of Ground... Coffee.....	36
7.10 Adjusting the beverage dispenser.....	37
7.11 Turning on/off the machine.....	38
7.12 First Use - Use after a Long Period of..... Inactivity.....	38
7.13 Washing the Parts coming into Contact with Food.....	39
7.14 Using the Appliance.....	39
8 PROGRAMMING MENU..... 40	
8.1 Accessing the programming menus.....	40
8.2 Button Description in Programming Mode.....	41
8.3 Enter values.....	42
8.4 Programming Menu.....	43
8.5 Setting user profiles passwords.....	61
9 OPERATION AND USE..... 62	
9.1 Turning on the Machine.....	62
9.2 Warm-up and Rinsing.....	63
9.3 Rinse/Self-Cleaning Cycle.....	63
9.4 Energy Saving mode.....	64
9.5 Dispensing beverages coffee only.....	64
9.6 Dispensing beverages with milk.....	65
9.7 Hot Water Dispensing.....	66
9.8 Using the Machine with Credits.....	67
9.9 Emptying the coffee grounds drawer and..... drip tray.....	67
9.10 "Touchless option".....	68
10 CLEANING AND MAINTENANCE..... 70	
10.1 General Notes for Correct Operation.....	70
10.2 Cleaning and Scheduled Maintenance.....	71
11 TROUBLESHOOTING..... 86	
11.1 Warning signals.....	86
11.2 Problems - Causes - Solutions.....	87
12 STORAGE - DISPOSAL..... 88	
12.1 Location Change.....	88
12.2 Inactivity and Storage.....	88
13 INSTRUCTIONS FOR END OF..... 89	
OPERATIONAL LIFE DISPOSAL.....	

I INTRODUCTION TO THE MANUAL

I.1 Preamble

 This publication is an integral part of the machine and has to be read carefully to ensure its correct use in accordance with the essential health and safety requirements.

 This manual contains the technical information necessary to properly perform the operating, installation, cleaning and maintenance procedures.

 Always refer to this manual before carrying out any operation.

This article is marketed under the responsibility of SaGa Coffee S.p.A. which guarantees the product. Saeco is a registered trademark of Koninklijke Philips N.V. and its use is licensed by Koninklijke Philips N.V.

 This publication should be carefully kept with the machine throughout its service life, including transfers of ownership.

 The manufacturer reserves the right to make changes without prior notice.

I.2 Icons Used

Various kinds of warnings are contained in this manual to highlight the different hazard or competence levels.

Each icon is followed by a message suggesting operating and behaviour procedures and providing useful information for the correct operation of the machine.

Warning

It is used to highlight danger situations for the persons in charge of using, refilling and servicing the machine.

Prohibition

It is used to highlight actions/operations not to be performed.

Important

It is used to indicate operations that, if correctly performed, preserve machine performance.



Suggested solutions

It is used to indicate alternative procedures which make programming and/or maintenance operations quicker.



User

It is used to indicate the user of the machine. Users are not allowed to perform any cleaning or maintenance operations.



Supply operator

It is used to indicate those operations that must be performed only by the person in charge of refilling and cleaning the machine.

Supply operators can not perform any operations requiring a Maintenance Technician.



Maintenance technician

It is used to signal those operations that must be performed only by the specialised maintenance technicians.

2 INFORMATION ABOUT THE APPLIANCE

2.1 Information for the Maintenance Technician

 The appliance must be installed in a well-lit, sheltered and dry place and on a table suitable to bear its weight.

To ensure its correct operation and reliability over time, comply with the following recommendations:

- ambient temperature: from +2°C to +32°C;
- maximum humidity allowed: 80% (non-condensed).

For special installations, not covered by this manual, please contact the dealer or the local importer. If this is not possible, please contact the Manufacturer.

The technical service is available for any explanation or information regarding the correct operation of the machine and to satisfy any request for spare parts supply or technical assistance.

The Maintenance Technician must carefully read and observe the safety warnings contained in this manual to ensure that installation, start-up, use and maintenance operations are performed in complete safety.

The Maintenance Technician is responsible for keeping or giving the keys to access internal parts of the machine to another operator (Supply operator), and is the sole responsible for any servicing procedure.

This manual is an essential part supplied with the machine and should always be available for reference before any operation on the machine.

2.2 Description and Intended Use

This machine is automatically used to brew:

- coffee and espresso coffee using instantly ground coffee beans;
- hot water to prepare beverages;
- milk-based beverages using the Cappuccinatore supplied. (*only versions M).

The elegant machine housing has been designed for use in small offices, businesses and institutions.

Using the machine for any other purpose is considered dangerous and as a misuse.

 Misuse voids all forms of warranty, releasing the Manufacturer from any responsibility for damage to property and/or personal injury.

 The following are also considered misuse:

- any use other than the intended use and/or employing methods other than those described in this manual;
- any operation on the machine in breach of the instructions provided in this manual;
- any tampering with parts and/or safety devices not previously authorised by the Manufacturer and performed by unauthorised personnel;
- machine installation in an outdoor environment.

In such cases the customer will be charged with the machine repair cost.

2.3 Appliance Identification

The appliance is identified by the model name and serial number shown on the special plate.

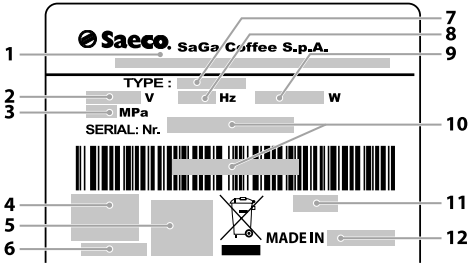

1	Name of the Manufacturer
2	Supply voltage (V)
3	Water mains pressure
4	Marks of conformity
5	Certifying organization
6	appliance code.
7	Model
8	Supply frequency (Hz)
9	Electrical power consumption (W)
10	Serial number
11	Year and month of manufacture
12	Country of manufacture

 It is strictly forbidden to tamper with or modify the data plate.

 When contacting the technical service, always refer to this plate by indicating the technical data shown on it.

2.4 Technical Data - version M2 and B2

Size (w x h x d)	280 x 470 x 481 mm	
Weight	approx. 15 kg	
Machine housing material	Thermoplastic material	
Power Rating	See the data plate	
Supply Voltage	See the data plate	
Power cord length	approx. 1,200 mm	
Capacity	Water tank	4.0 litres
	Coffee grounds drawer	30 grounds
Control panel	Front panel	
A-weighted sound pressure level	less than 70 dB	
Pump pressure	Max. 1.5 MPa (15.0 bar)	
Operating conditions	Minimum temperature: above 2°C Maximum temperature: less than 32°C Maximum humidity: less than 80%	
Safety devices	Boiler pressure safety valve Safety thermostat	

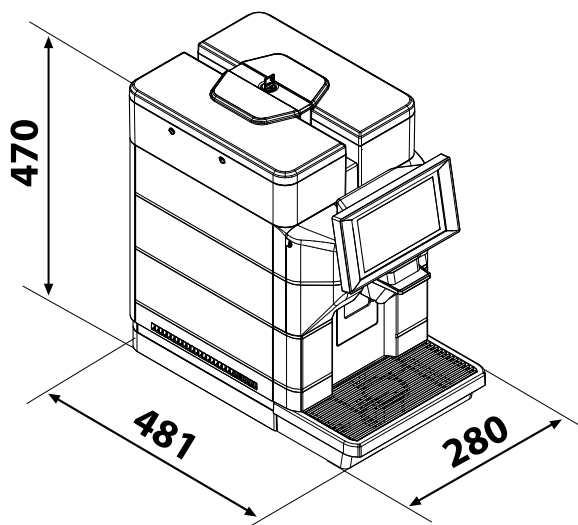

Subject to engineering and manufacturing changes due to technological improvements.

2.5 Technical Data - version M2+ and B2+

Size (w x h x d)	280 x 470 x 481 mm	
Weight	approx. 15 kg	
Machine housing material	Thermoplastic material	
Power Rating	See the data plate	
Supply Voltage	See the data plate	
Power cord length	approx. 1,200 mm	
Water mains connection	3/4" Gas type	
Water mains pressure	See the data plate	
Capacity	Water tank	4.0 litres
	Coffee grounds drawer	30 grounds
Control panel	Front panel	
A-weighted sound pressure level	less than 70 dB	
Pump pressure	Max. 1.5 MPa (15.0 bar)	
Water connections (for water NW version only)	Maximum pressure	0.8 MPa (8 bar)
	Minimum pressure	0.15 MPa (1.5 bar)
Operating conditions	Minimum temperature: above 2°C	
	Maximum temperature: less than 32°C	
	Maximum humidity: less than 80%	
Safety devices	Boiler pressure safety valve Safety thermostat	

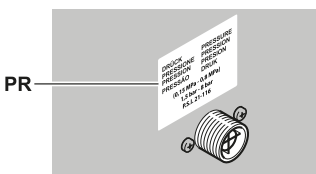
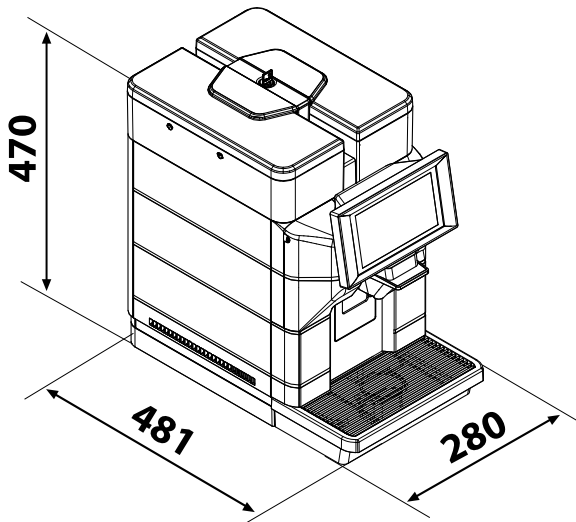

PR Data plate for maximum water supply pressure

Subject to engineering and manufacturing changes due to technological improvements.

2.6 Technical Data - version MI and BI

Size (w x h x d)	280 x 435 x 481 mm	
Weight	approx. 12 kg	
Machine housing material	Thermoplastic material	
Power Rating	See the data plate	
Supply Voltage	See the data plate	
Power cord length	approx. 1,200 mm	
Capacity	Water tank	2.5 litres
	Coffee grounds drawer	30 grounds
Control panel	Front panel	
A-weighted sound pressure level	less than 70 dB	
Pump pressure	Max. 1.5 MPa (15.0 bar)	
Operating conditions	Minimum temperature: above 2°C Maximum temperature: less than 32°C Maximum humidity: less than 80%	
Safety devices	Boiler pressure safety valve Safety thermostat	

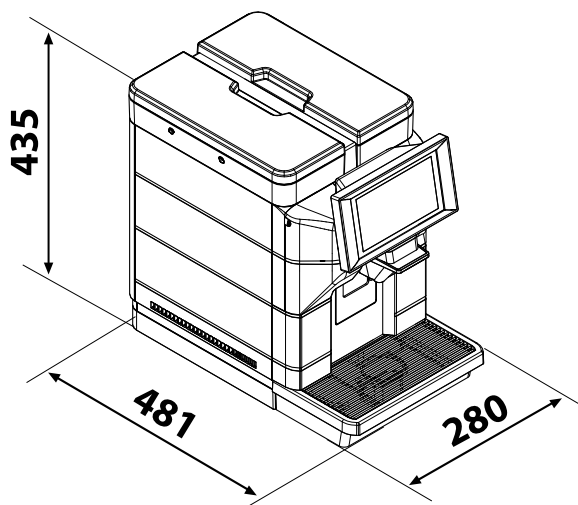

Subject to engineering and manufacturing changes due to technological improvements.

3 SAFETY

3.1 Preamble

In compliance with the regulations and directives in force, SaGa Coffee has established at its offices a technical pamphlet relative to the MAGIC appliance.

3.2 General Safety Instructions

It is forbidden to:

- tamper with or disable the safety systems installed on the machine;
- service the machine prior to unplug the power cord;
- install the appliance outdoors. It is advisable to place it in a dry place where the temperature does not drop below 2°C, in order to prevent any possible freezing.
- use the appliance for purposes other than those indicated in the sale contract and in this manual;
- electrically connect the appliance using multi-sockets or adapters;
- immerse the appliance in the water;
- use jets of water for cleaning operations.

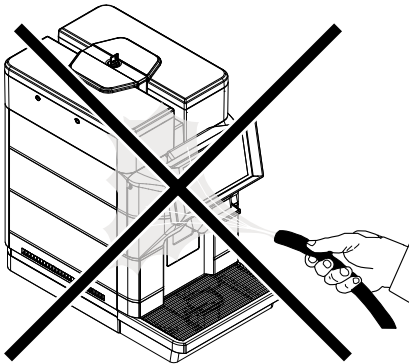



It is mandatory to:

- check conformity of the power supply;
- use original spare parts;
- carefully read the instructions contained in this manual and in the attached documents;
- use personal protective equipment when performing installation, testing and maintenance operations.

Precautionary measures to prevent human errors:

- make the operator aware of safety issues;
- handle the appliance, either packaged or unpackaged, in complete safety;
- deeply know the installation procedures, its correct operation and its limits;
- dismantle the appliance in complete safety, in accordance with the workers' health and environmental protection regulations in force.

 To prevent machining residues from coming into contact with the beverages, dispense about 0.5 l of water for each dispensing path before definitely starting the machine. The dispensed beverages can be drunk only after performing this operation.

 In case of failure or malfunctioning, please refer only to the qualified personnel of the technical service.

 The manufacturer is not liable for damage to persons or property resulting from failure to follow the safety instructions provided in this section.

3.3 Operator Requirements

Three operators with different skills are required in order to guarantee the appliance's safety:

 User

The user is not allowed to access the internal parts of the machine.

 Supply operator

Only the Maintenance Technician is allowed to keep the keys to access the internal parts of the machine, and is in charge of refilling the machine with products, cleaning the outside of the appliance, turning it on and off.

 The Supply operator is not allowed to carry out operations indicated in this manual as competence of the Maintenance Technician.

 Maintenance technician

The maintenance technician is the only person authorised to service the machine, start the programming procedures and perform the adjustment, set up and maintenance operations.

 Access to the internal area is restricted to persons having knowledge and practical experience of the appliance, in particular as far as safety and hygiene are concerned.

3.4 Residual Risks

 The dispensing outlet has no guards to prevent accidental hand contact with coffee or hot water.

 Risk of burning if the hands are placed inside the outlet during beverage brewing.

 Before brewing a beverage make sure that the previous one has already been picked up and that the cup support is empty.

4 HANDLING AND STORAGE

 All the operations described in this chapter must be performed exclusively by the service provider or a specialised technician, who shall organise all the operating steps and use only suitable means to ensure strict compliance with the safety regulations in force.

4.1 Unloading and Handling

Unloading from the transport vehicle and handling operations of the appliance must be carried out by qualified personnel only and using suitable equipment.

 The appliance must always be kept in upright position.

 Do not:

- drag the appliance;
- overturn or lay down the appliance during transport and handling;
- shake the appliance;
- lift the appliance by using ropes or cranes;
- leave the appliance exposed to bad weather, in humid areas or close to heat sources.

4.2 Storage

The machine is contained in cardboard packages.

If the appliance is not immediately installed, it shall be kept in a sheltered place according to the following instructions:

- the packaged appliance shall be stored in a closed, dry area at a temperature between 1°C and 40°C;
- maximum humidity below 90% (non-condensed);
- do not put other appliances or boxes on the appliance;
- in any case, it is good practice to protect the appliance from possible deposits of dust or other substances.

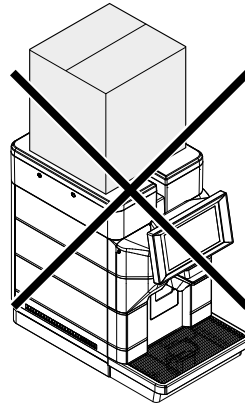

 Due to the total weight, do not stack more than three machines on top of each other. The machine should be stored in its original packaging, in a dry and/or dust-FREE place.

5 INSTALLATION

 All the operations described in this chapter must be performed exclusively by the service provider or a specialised technician, who shall organise all the operating steps and use only suitable means to ensure strict compliance with the safety regulations in force.

5.1 Cautions

 The appliance cannot be installed in external areas. Avoid placing it in areas where the temperature is lower than 2°C or higher than 32°C and in particularly humid or dusty places. It should neither be installed in places where water jets are used for cleaning operations nor where there is a risk of fire or explosion.

Make sure that the installation place is compatible with the following specifications, before unpacking the appliance:

- the power socket which the appliance is connected to should be easily accessible and at a distance not higher than 1.2 metres;
- the gradient of the supporting surface should NOT exceed 2°;
- the socket voltage must correspond to that indicated on the appliance data plate.

 The appliance must be installed on a horizontal surface.

 The supporting surface must be adequate to bear the machine weight and clean.

 Access to the machine and the plug should be kept clear at all times in order to allow users to easily reach them and to leave the area immediately if required.

The following illustration shows the required access distances:

- to the keypad on the front of the appliance;
- to the service units in the event of failure.

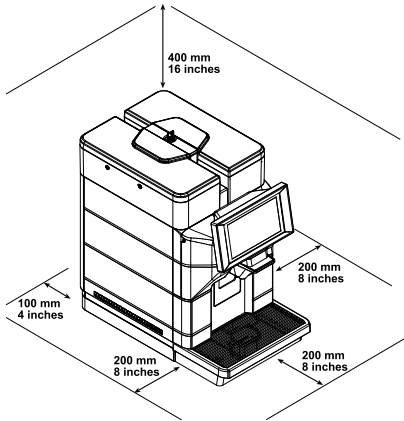

⚠ The presence of magnetic fields or proximity to electrical machines which generate interference could cause the electronic controls of the machine to malfunction. At temperatures close to 0°C, internal parts containing water are at risk of freezing. Do not use the machine under these conditions.

5.2 Unpacking and Positioning

On receipt of the appliance, make sure that it has not suffered any damage during transport or that the packaging has not been unduly opened with consequent stealing of the components contained in it. If damage of any kind is found, the courier must be informed and notice must be immediately given to the importer or to the seller. If these are not in the purchaser's country, please contact the manufacturing company directly. An accessories bag is supplied with the machine.

List of Standard Accessories

Manual: instructions on how to use the machine.

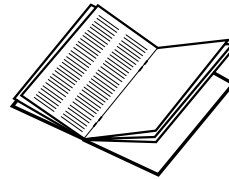

Key to access water tank and container of coffee beans: prevents access to the water tank and the container of coffee beans by unauthorized personnel. (* only versions M2, M2+, B2 and B2+).

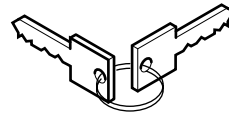

Power cord: to connect the machine to the mains.



Cappuccinatore: allows you to dispense milk-based beverages. (*only versions M).

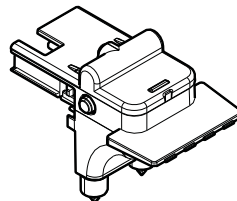

Water hardness test: quick test to determine the actual hardness of the water used to prepare beverages; this test is of fundamental importance to set the water hardness in the machine.

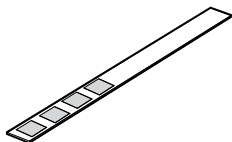

"Intenza +" water filter: to remove any unpleasant flavours in the water and reduce water hardness. This will improve machine use.



Cleaning brush: to remove the coffee powder from the service compartment.

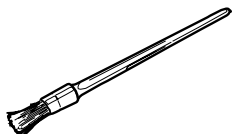

Lubricating grease: to lubricate the Brew Group at periodic intervals.

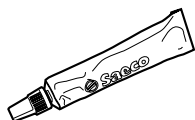

Milk circuit cleaning powder: allows a correct and thorough cleaning of the circuit, removing all possible milk residues. (*only versions M).



Group cleaning tablets: allow a correct cleaning of the brew group, increasing its durability.



List of Optional Accessories

Descaling solution: to remove limescale build-up in the water circuit caused by normal use.



List of accessories not supplied

3/4 flexible hose for water mains connection.

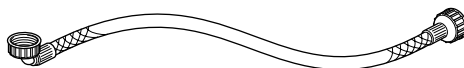



5.3 Connection and setting for the water mains

(*only versions M2+ and B2+)

 This operation must only be performed by specialised technical personnel or by the service provider.

 Connect the appliance to a drinking water distribution pipe with pressure between 0.15 MPa and 0.8 MPa (1.5 and 8 bar), see data on the label.

 We recommend using a descaling device for the water network that supplies water to the appliance, especially for water with high levels of calcium and magnesium salts (hard water).

 Before connecting the appliance to the water mains, please read and follow the applicable regulations in force in your country.

Remove the cap from the coupling on the appliance rear part.

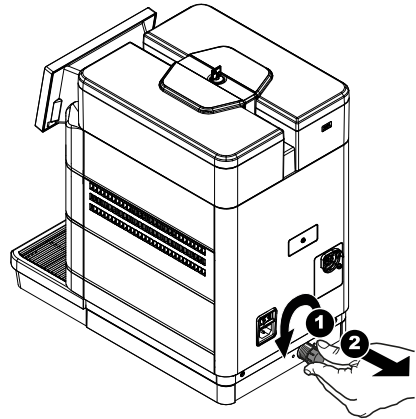

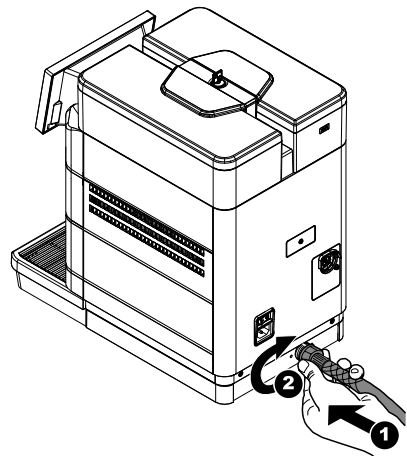

Connect the water network hose to the appliance's 3/4" threaded coupling.

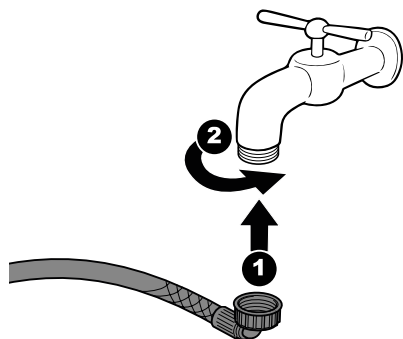

 The water mains hose is to be certified according to the IEC 61770 standard.

Screw the supply hose to a cold water knob with a 3/4 gas threaded spout.



 Ensure that the hose is free of kinks and twists.

Open the water knob.

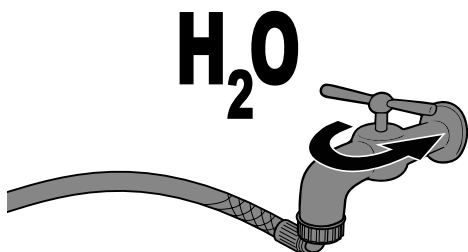

 Two litres of water must be poured into the water tank for the first filling of the machine's hydraulic circuit. This operation must be carried out with the machine switched off, before it is switched on for the first time.

Remove the protection cover as described in section "Opening the Upper Lid". Remove the lid from the water tank. Remove the tank; lift it using the inside handles. Rinse the water tank and pour in 2 litres of water.

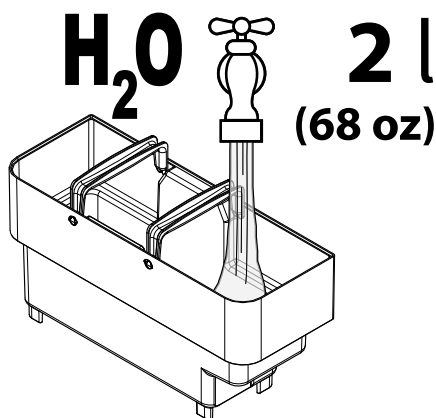

Insert the water tank back into its seat and refit the lid. Connect the machine to the electric mains as explained in the section "Connecting to the electric mains". Switch the machine on by turning the main switch at the rear of the machine to position "I".

 Wait for the hydraulic circuit to load.

Access the programming menu by pressing the "settings" icon.



Enter the password of the technical profile. Select "Machine settings", then "Other settings". Enable "Water main".

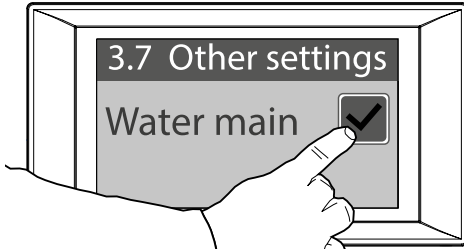

Remove the lid from the water tank. Remove the cap from the water tank. Keep the cap just removed for future use of the machine set to water tank.

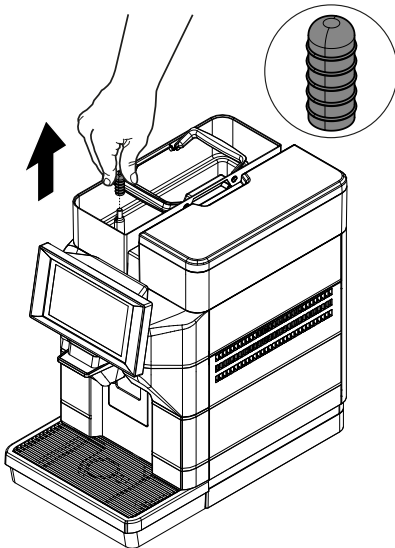

Reinsert the water tank cover. Refit the protection cover as described in section "Closing the Upper Lid". Save the settings and exit the programming menu.

At this point the machine is set for operation via the water mains and the relevant icon appears in the top right-hand corner of the ready-for-use screen.

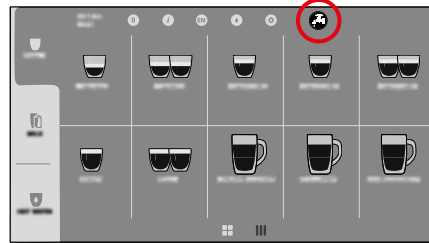

⚠ Do not remove the water tank while the machine is switched on.

The machine does not recognise the presence of the tank, only the water level. In the case of operation using the water mains, the solenoid valve opens when the water level is below the minimum. If the water tank is not present, the water fills the top cover tank, flows down the drain and blocks the solenoid valve. At this point, the machine no longer runs on the water mains. You can continue to use the machine but it must be set to water tank. To reset the machine from water main to water tank, disable the "Water main" item in the programming menu item "Machine settings", sub-item "Other settings" and reinsert the previously removed cap into the water tank. Fill the water tank with fresh drinking water; do not exceed the level (MAX) indicated on the tank.

A technician is required to restore the water mains.

5.4 Connection to the Electric Network

 This operation must only be performed by specialised technical personnel or by the service provider.

The Maintenance Technician, who is in charge of the appliance's installation, shall make sure that:

- the power supply system complies with the safety instructions in force;
- the voltage corresponds to that indicated on the appliance data plate.

 In case of doubt, do not proceed with the installation and ask qualified and authorised personnel to accurately check the system.

 Do not use adapters or multi-sockets.

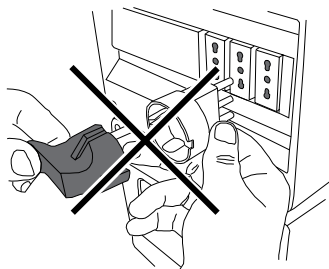

 Make sure that the power cord plug is easily reachable after installation.

6 DESCRIPTION OF CONTROLS

6.1 Power button

It is located in the rear of the machine. If set to the "I" position the machine turns on (electrical functions enabled). If set to the "O" position the machine turns off (electrical functions disabled).

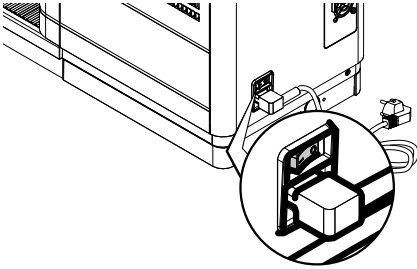

Move and drag

To move and drag icons and objects, tap and drag them to a new location.

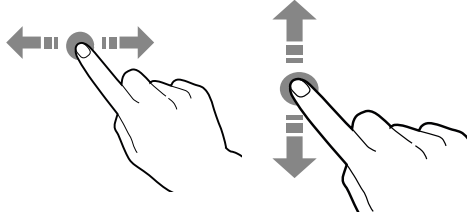

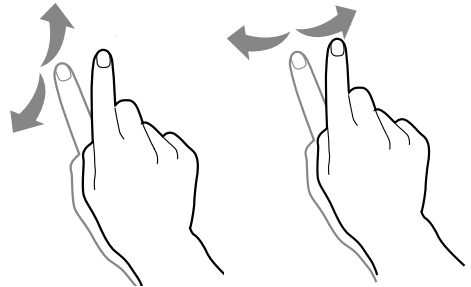

Scroll

Slide your finger to the right, left, up or down on the touchscreen to scroll through the values, screens and functions.



6.2 Touch Screen Control Panel

 Only use fingers to interact with the touchscreen; do not use sharp objects.

 Using high-quality content will affect the general performance.

Tap

Tap icons, functions and objects to activate or open context menus.



6.3 Operating in normal user mode

The layout and arrangement of the icons/screens in this manual is indicative only and may vary from those displayed on the appliance, depending on the settings (layouts, themes, and/or icons). When operating normally, the appliance displays the screen with the available selections. In the event that an anomaly is detected by the control electronics, a message will be displayed, indicating the fault/error. Some selections may be disabled when certain types of faults occur (e.g. product containers empty, etc.). With some of the personalised settings (i.e. moving the beverages to a different place) some selections may not be displayed: simply scroll through the screen.

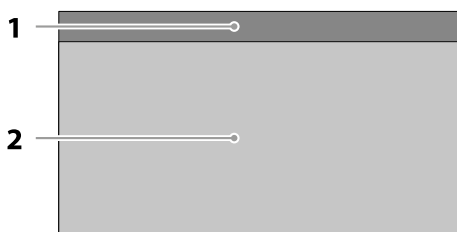

1	Status panel
2	Beverage selection area

Display the status panel in detail

Tap the icons shown in the upper part of the touchscreen.

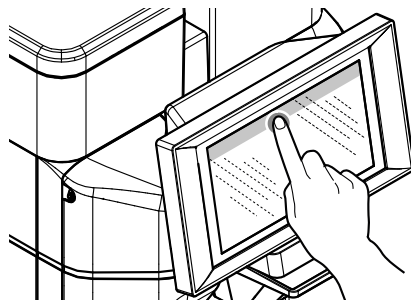

Close the details of the status panel

Drag the bottom of the status panel upwards.

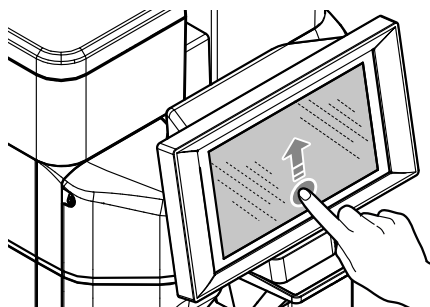

6.3.1 Status panel

The appliance status can be displayed (e.g. faults, etc.) via the status panel.

The status panel:

- Displays fault/error notifications
- Displays the nutritional information of the selections
- Allows the language of the displayed messages to be changed
- Displays the notice to fill the trays and containers
- Displays the available wash functions
- Provides access to the programming menu

6.3.2 Beverage selection area

Select a beverage. The screen with the beverage customisations can be displayed.

Whilst the beverage is being prepared, the beverage's preparation status is shown. alternatively it is possible to see the entertainment contents (e.g. a video).

If enabled in menu, it is possible to stop a beverage's preparation.

7 SUPPLY AND START UP

7.1 Opening the Upper Lid

(* only versions M2, M2+, B2 and B2+).

The upper protection cover should be removed in order to fill the containers. The cover is a safety device which allows access only to authorised personnel. Unlock the lid with the special key supplied to remove it.

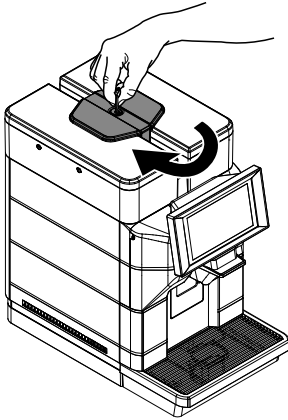

After unlocking the lid, lift and remove it.

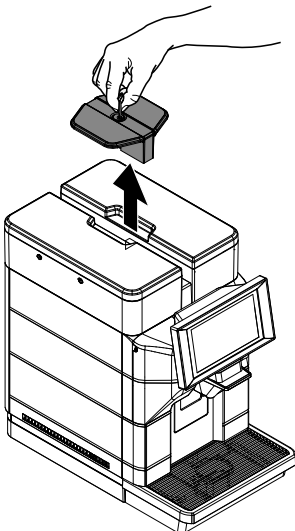

Now the water tank and the coffee bean hopper can be filled.

7.2 Coffee Blends

- We recommend using fresh, non-oily and medium-ground coffee.
- Use an espresso coffee blend.
- Use the special blends for espresso machines to obtain a strong and aromatic coffee.
- Keep coffee in a cool place in an airtight sealed container.

7.3 Coffee Bean Supply

 Only coffee beans must be put into the coffee bean hopper. Do not insert pre-ground coffee, instant coffee or any object that may damage the machine.

Remove the protection cover as described in section "Opening the Upper Lid". (only versions M2, M2+, B2 and B2+).

Remove the coffee bean hopper lid.

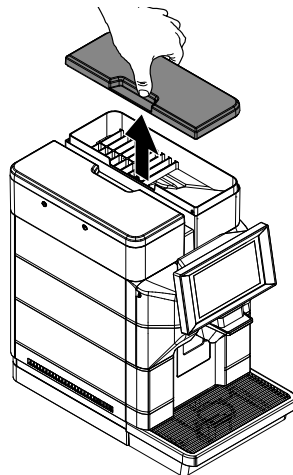



 The coffee grinder contains moving parts that may be dangerous. Do not insert fingers and/or other objects.

 The coffee bean hopper may be provided with different safety features according to the regulations of the country of use of the machine.

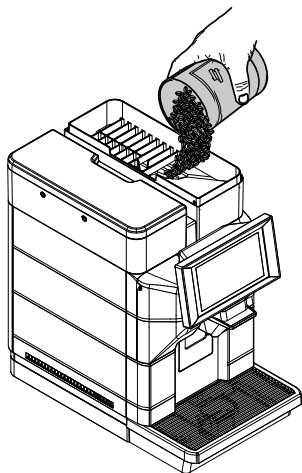
Pour the coffee beans into the hopper.



 When filling the coffee bean hopper, use sterile disposable gloves to prevent bacteriological contamination.

 If the water tank is not inserted, check that no coffee beans fall into the tank compartment. If this happens, remove them to avoid any malfunctions.

Refit the coffee bean hopper lid.

Refit the protection cover as described in section "Closing the Upper Lid". (only versions M2, M2+, B2 and B2+).

7.4 Filling the Water Tank

 If the appliance is connected and set to the water mains, fill the water tank only to perform the descaling operation.

 Before using the machine for the first time, wash the water tank carefully. Fill the water tank with fresh drinking water only. Hot or carbonated water, as well as other liquids, will damage the machine.

Remove the protection cover as described in section "Opening the Upper Lid". (only versions M2, M2+, B2 and B2+).

Remove the lid from the water tank.

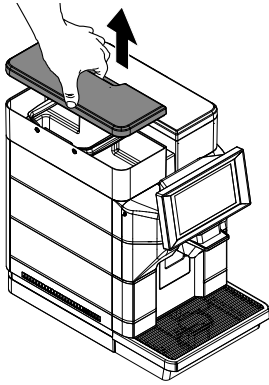

Remove the tank; lift it using the inside handles.

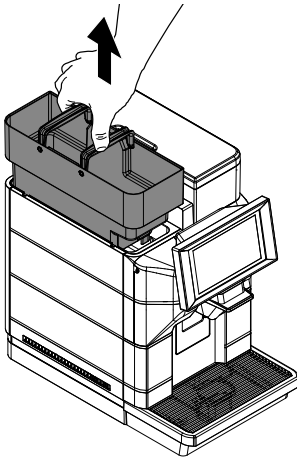

Rinse and fill it with fresh water; do not exceed the level (MAX) indicated on the tank.

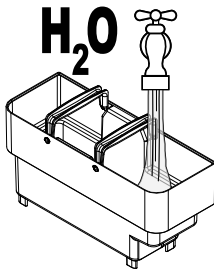

 When filling the water tank, use sterile disposable gloves to prevent bacteriological contamination.

Insert the water tank back into its seat and refit the lid.

Refit the protection cover as described in section "Closing the Upper Lid". (only versions M2, M2+, B2 and B2+).

7.5 Measuring and Adjusting Water Hardness

Measuring water hardness is very important in order to correctly manage the anti-scale filter and the frequency with which the machine must be descaled. Immerse the water hardness test strip in water for 1 second.

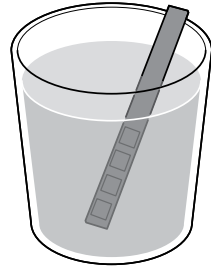

 the test strip is only valid for one measurement.

Check how many squares change their colour and then consult the table.

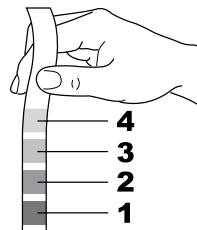

The numbers correspond to the settings indicated in the following machine adjustments.

1	HARDNESS 1 (very soft)
2	HARDNESS 2 (soft)
3	HARDNESS 3 (medium)
4	HARDNESS 4 (hard)

Access the programming of the machine as described in the paragraph "Access to the programming menus". Tap the "menu" icon to view the appliance's menu functions.



Select "Machine settings". Select "Maintenance". Select "Descaling settings". Set the value found in the measurement.

 The machine is supplied with standard adjustments, suitable for most uses.

After adjusting the water hardness, install the anti-scale filter as described in the following section.

7.6 Water filter

 This water filter can only be used if the machine is not set to the water mains.

Water is a key element for a good espresso coffee. Therefore, it should always be filtered in a professional manner. This is why all machines can be equipped with a water filter. This filter is easy to use and its sophisticated technology is effective in preventing limescale build-up. This way, water will always be perfect and will give a much more intense aroma to your espresso coffee.

 Measuring water hardness is very important in order to correctly manage the water filter and the frequency with which the machine must be descaled.

 The anti-scale filter should be replaced whenever indicated by the machine.

 Before descaling, remove the anti-scale filter from the water tank.

Remove the water filter from its packaging. Set the filter in the standard position on letter B. Use the water hardness test strip provided with the machine. Set the "Intenza Aroma System" as specified on the filter package (see section "Measuring and Adjusting Water Hardness").

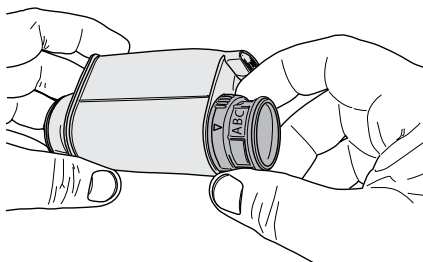

A	Soft water
B	Hard water (standard)
C	Very hard water.

Immerse the water filter vertically in cold water (with the opening positioned upwards) and gently press its sides to let the air bubbles out.



Remove the tank from the machine and empty it. Remove the small white filter from the tank and store it in a dry place sheltered from dust.

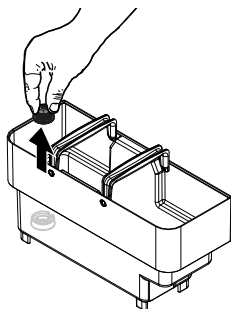

Put the filter into the empty tank. Press it to its limit stop.

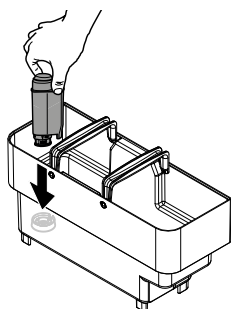

Fill the tank with fresh drinking water and reinsert it into the machine. Place a container under the hot water dispensing spout.

Access the programming of the machine as described in the paragraph "Access to the programming menus". Tap the "menu" icon to view the appliance's menu functions.



Select "Machine settings". Select "Maintenance". Select "Water filter settings". Activate the water filter.

Once the operation is finished fill the water again up the MAX level with fresh drinking water. The Filter 100% icon appears on the machine-ready screen to indicate that the filter has been installed.

7.6.1 Replacing the water filter

 The filter icon turns red when the range of the filter drops below 10%. Replace the filter when the notice is displayed or when its range is below 1%.

 Replace the water filter at least every 3 months, even if the machine has not yet indicated the need to replace it.

Pull out the water filter. Follow the steps indicated in the "Water filter" section. Replace the filter and activate the new one. The display automatically updates the number of filters used. This datum is updated on the menu only if the user has installed a new filter before exhausting the previous one, or in any case, not exceeding the eighth filter in a row. Fill the water tank again up to the MAX level with fresh drinking water.

Replacing the Filter after Using 8 Filters

Pull out the water filter. Follow the steps indicated in the "Water filter" section. All operations relating to the descaling phase are requested as well. The display updates the number of used filters automatically, taking it to 0/8. However, only after descaling has finished and before the new filter activation. Fill the water tank again up to the MAX level with fresh drinking water.

7.7 Closing the Upper Lid

(* only versions M2, M2+, B2 and B2+).

After refilling and during normal operation, the upper protection cover must always be fitted and locked using the special key in order to prevent access to unauthorised people. In order to lock the upper lid, position it and close it using the special key supplied.

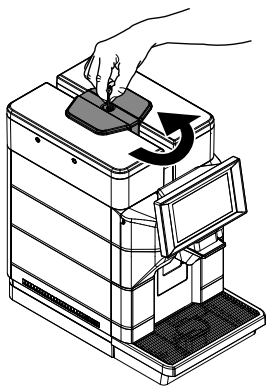

7.8 Coffee Grind Adjustment

The machine allows the coffee grind to be slightly adjusted in order to adapt it to the kind of coffee used. For any adjustments, use the lever located on the inner side of the service compartment.

Remove the drip tray.

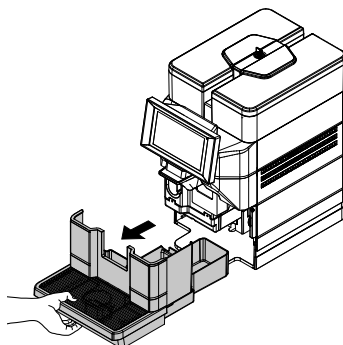

Remove the screw preventing accidental opening of the service compartment flap. (* 120V USA version only).

Open the service compartment door and turn the lever by only one notch.

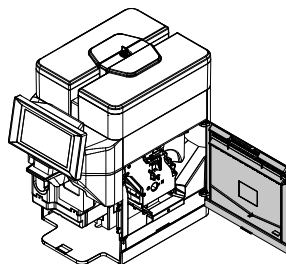

Close the door again and brew 1-2 cups of coffee to verify the changes in the grinding degree. Repeat the procedure until you reach the desired grind setting.

Re-insert the screw preventing accidental opening of the service compartment flap. (* 120V USA version only).

The reference marks indicate the grind setting. There are different grind settings to choose from with the following references:

- 1 - Fine grind
- 2 - Coarse grind

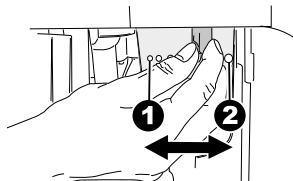

7.9 Adjusting the "Aroma" - Amount of Ground Coffee

The machine makes it possible to regulate the quantity of coffee being ground for the preparation of every single coffee-based beverage. The regulation must be done by accessing to programming menu of the machine. Modifying the quantity of coffee ground in the recipes of the beverages. The reference marks indicate the amount of ground coffee which has been set. Different quantities of ground coffee can be set for every recipe with the following references:

- 1 - Minimum coffee quantity
- 4 - Maximum coffee quantity

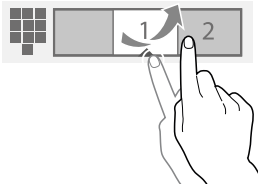

The amount of coffee that is ground can be further adjusted via the Aroma adjustment lever.

 This operation may only be carried out by specialised technical personnel.

 The Aroma adjusting lever must only be turned when the coffee grinder is stopped. The adjustment must be performed before brewing coffee.

 DO NOT change the coffee dose if the pre-grinding option is active (set on "ON").

The adjustment can be done using the lever located on the side in the service compartment of the machine. Remove the drip tray.

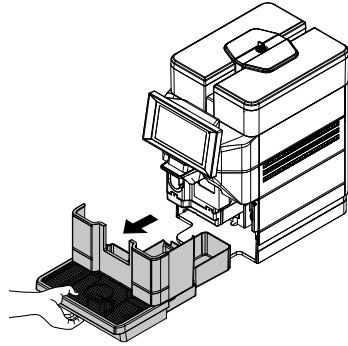

Remove the screw preventing accidental opening of the service compartment flap. (* 120V USA version only).

Open the service compartment door.

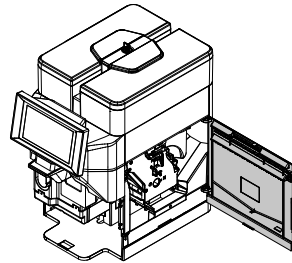

The reference marks indicate the amount of ground coffee which has been set.

- A - Minimum coffee quantity
- B - Maximum coffee quantity

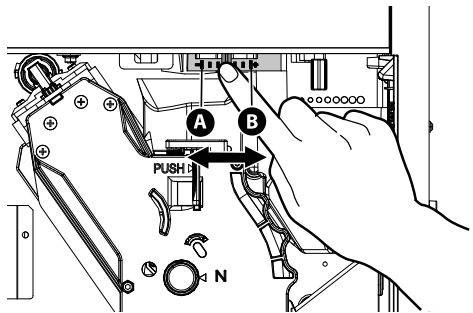

The following figure shows the default setting of the position of the adjusting lever.

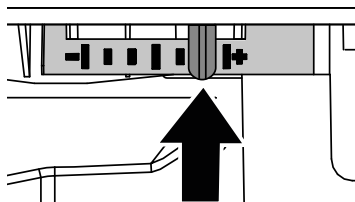

7.10 Adjusting the beverage dispenser

Most of the cups and mugs available on the market can be used with this coffee machine. The height of the dispensing spout can be adjusted to better fit the dimensions of the cups that you wish to use. Manually move the dispensing spout up or down to adjust its height.

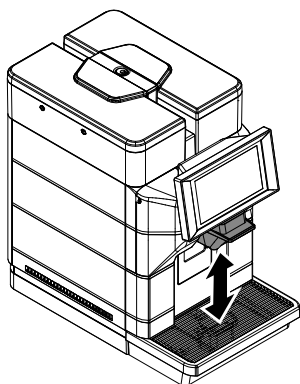

The recommended positions are:

- When using small cups.

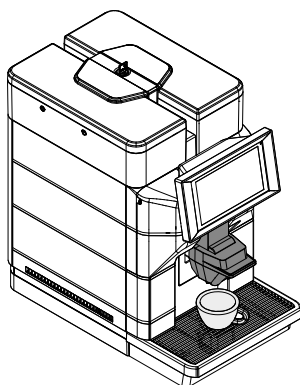

- When using mugs.

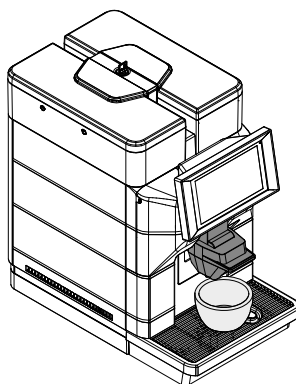

- To use tall glasses.

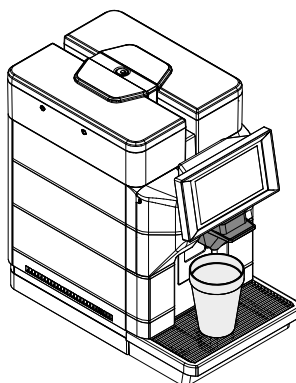

Two cups can be placed under the dispensing spout to brew two cups of coffee at the same time.

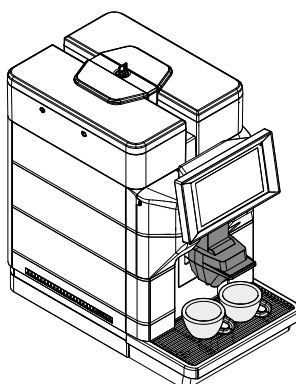

7.11 Turning on/off the machine

The machine can be turned on/off by pressing the button located to the rear of the machine.

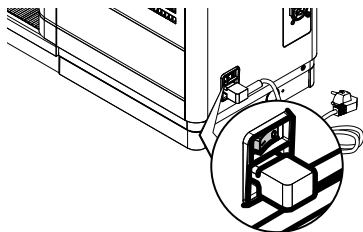

7.12 First Use - Use after a Long Period of Inactivity

Refill the machine (follow the instructions above). Connect the plug of the appliance to the mains (see section "Connection to the Electric Network"). For a perfect Espresso: rinse the coffee circuit if using the machine for the first time or after a long period of inactivity. These simple operations will allow you to always brew excellent coffee.

They have to be performed:

- at first start-up;
- when the machine remains inactive for a long time (more than 2 weeks).

 If the machine fails its first start-up (brewing) make 2 further attempts. At the end of these 3 attempts, if the problem is not solved, let the machine rest for 30 minutes and then try again with 3 brewings. If the problem persists, please contact Customer Service.

7.12.1 After a Period of Inactivity

Empty the water tank, wash and rinse it.

 If the appliance is connected and set to the water mains, this operation must be carried out with the machine switched off.

Fill the water tank. (Only if the appliance is not connected or set to the water mains).

Place a large container under the dispensing spout.

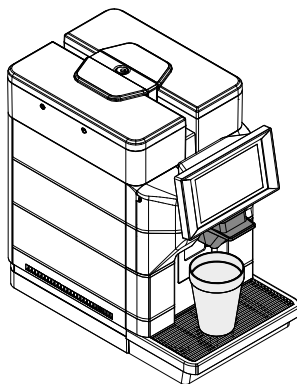

Press the icon of a coffee beverage to start dispensing. The machine starts brewing coffee from the dispensing spout. Wait until brewing has been completed and empty the container. Repeat the brewing process 3 times.

Place a large container under the dispensing spout.

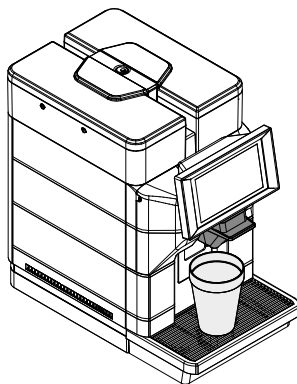

Press the "Hot Water" beverage icon to start dispensing HOT WATER. When the hot water dispensing procedure has been completed, empty the container. The machine is now ready for use.

7.13 Washing the Parts coming into Contact with Food

Rinse all the parts coming into contact with food.

- Thoroughly wash your hands.
- Prepare a chlorine-based, antibacterial disinfecting solution (the products can be purchased at the chemist's) following the concentrations indicated on the product.
- Remove all the covers and all the containers from the appliance.
- Immerse all these parts in the previously prepared solution.

7.14 Using the Appliance



Before using the machine, read this manual carefully and make sure users are familiar with the machine.





After the machine has not been used for a certain time, it is recommended to read section "First Use - Use after a Long Period of Inactivity" again, before using the module again.

The beverage selection modes are indicated in chapter "Operation and Use".

8 PROGRAMMING MENU

 This chapter contains instructions on how to set and change the programming parameters of the appliance.

 Therefore it is necessary to carefully read it and to understand the exact sequence of operations before performing them.

 All the operations described in this chapter must be performed exclusively by the service provider or a specialised technician, who shall organise all the operating steps and use only suitable means to ensure strict compliance with the safety regulations in force.

The specialised technician or the service provider can change some of the machine operating parameters to suit the needs of the users.

Notes on programming

The electronic control unit of the appliance allows many functions to be used. A brief explanation of these main functions is listed below. They are useful for better managing the appliance's operation but are not necessarily in the same order as they are displayed in the menu.

Some functions that are specific to certain functional units may be listed; functional units that differ according to the model.

The layout of the icons/screens in this manual is indicative only and may vary from those displayed on the appliance, depending on the settings (layouts, themes, and/or icons).

8.1 Accessing the programming menus

Access the programming menus as follows:

with the door of the service area close, tap the "settings" icon;



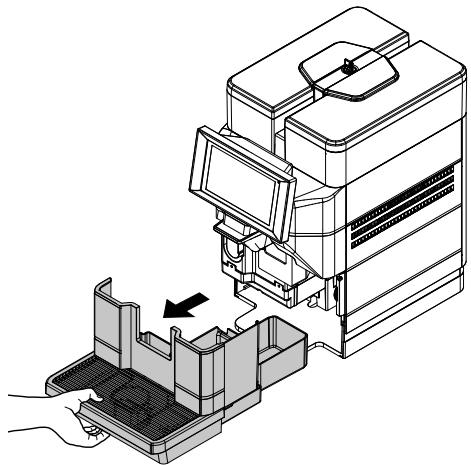

or
Remove the drip tray.

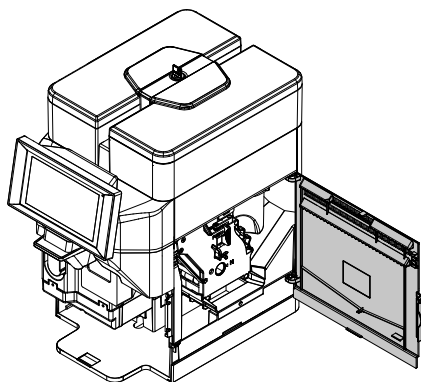

Remove the screw preventing accidental opening of the service compartment flap. (* 120V USA version only).

Open the service compartment door.



 Access the menus by opening the door only if it is not possible to enter normally from the tablet.

Depending on the settings, a password may be required to access the programming menus. Enter the password to access the enabled menus.

There are 2 levels of access to the programming menus depending on the rank of the operator. The possible levels are:

- User
- Technician

The first screen after access to the programming menu is divided as follows:

- Controls Bar
- Information Area
- Message Area
- Faults Area
- Maintenance Information Area

Controls Bar

Displays the icons of the available controls.

Information Area

Displays information regarding the appliance (software version, etc.).

Message Area

Displays messages of an informative nature, e.g. statistics on the most requested selections, etc.

Faults Area

Displays the faults found on the appliance.

Maintenance Information Area

Displays information regarding the maintenance deadlines. Maintenance notification sets the current date/time as the last date of maintenance.

8.2 Button Description in Programming Mode

Menu



Tap the "menu" icon to view the appliance's menu functions. All the functions are displayed and only those for the profile of the current operator are enabled. Some of the functions and/or parameters may not be displayed: simply scroll through the screen.

Exit



Tap the "exit" icon to get out of the programming menus. The selections page will be displayed.

Favourites



The favourites are links with the functions frequently used. After having added a function to the "favourites," simply view the "favourites" and tap the function for quick access. Tap the "favourites" icon to access the functions used frequently and stored as favourites.

Add a function to "favourites"

From the function tap the "empty star" icon.



It will change colour (it turns on)



Remove a function from "favourites"

From the favourites screen, tap the function to be removed in order to access that function.
Tap the "full star" icon.



It will change colour (it turns off)



Numeric keypad



Tap the "numeric keypad" icon to display the numeric keypad.

8.3 Enter values

The values of the programming menu can be entered/modified as follows:

- Keypad
- Numeric keypad
- Check-box
- Drop-down lists
- Value selectors

Keypad



1	Uppercase (shift)
2	Switch the "number/symbol" keypad to the "letter" keypad
3	Switch the "letter" keypad to the "number/symbol" keypad
4	Caps lock
5	Moves the cursor in the text
6	New line (text over two lines)
7	Confirm
8	Cancel
9	Clear (back space)

Numeric keypad

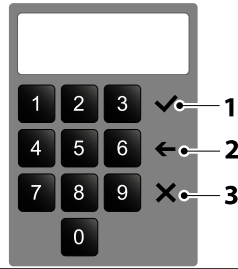

1	Confirm
2	Clear (back space)
3	Closes the keypad

Check-box

Tap the check-box to enable/disable the option.

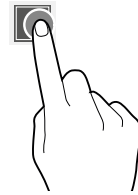

Drop-down lists

Tap to open the drop-down list and select the value.



Value selectors

Scroll and select the desired value.

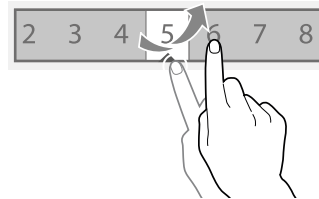

8.4 Programming Menu

The structure of the programming menu is indicated in section "Structure of the Programming Menu".

The "Description items of the programming menu" describes all the items included in the programming menu.

8.4.1 Structure of the Programming Menu

This menu allows you to manage certain machine operation parameters.







The items of the programming menu are:









OPTION NO.	MENU ITEM
0	Menu
1	Daily actions
1.1	Washing/rinsing
1.2	Emptying the residue trays
2	Beverage settings
2.1	Display
2.2	Categories
2.3	products
2.3.1	Beverages displayed
2.3.2	Beverages available
2.3.3	Beverages not available
2.4	Recipes
2.4.1	Recipes in use
2.4.2	Recipes available
2.4.3	Recipes not available
2.5	Containers
3	Machine settings
3.1	Machine Configuration
3.1.1	Selection of the configuration
3.1.2	Backup and Restore
3.1.3	Import from a USB
3.1.4	Export via a USB
3.2	Configuration of the translation
3.2.1	Edit Translations
3.3	Display settings
3.3.1	Customising the interface graphics
3.3.1.1	Edit
3.3.1.2	Select
3.3.1.3	Import interface graphics
3.3.1.4	Export interface graphics customisation
3.3.2	GUI package
3.3.3	General settings of the display
3.3.4	Playlist
3.4	Input settings
3.4.1	Solid residues settings
3.5	Output settings
3.5.1	Espresso settings
3.5.2	Audio settings





OPTION NO.	MENU ITEM
3.6	Maintenance
3.6.1	Automatic rinse
3.6.2	Descaling settings
3.6.3	Water filter settings
3.7	Other settings
4	Information on the machine
4.1	Failures
4.1.1	Current status
4.1.2	Fault history
4.1.3	Event History
4.2	Statistics
4.2.1	Display statistics
4.2.2	Reset statistics
4.2.3	Show Audit
4.2.4	Beverage items numbers
4.2.5	EVA-DTS Customisation
4.3	Favourites menu
4.3.1	Favourites list
4.3.2	Eliminate favourites
4.4	Machine Number and Name
4.5	Installation date
4.6	Contacts Information
5	Energy Saving mode
5.1	Energy Saving settings
5.2	Energy Saving time frames
6	Payment Systems
6.1	Protocol
6.1.1	GENERAL SETTINGS
6.1.2	MDB
6.1.2.1	Coin mechanism
6.1.2.2	MDB coin settings
6.1.2.2.1	Accepted
6.1.2.2.2	Exact change accepted
6.1.2.2.3	Returned
6.1.2.2.4	Vend token value
6.1.2.2.5	Exact change settings
6.1.2.3	Device without change
6.1.2.4	Check keys without cash
6.1.2.5	Banknote acceptor
6.1.2.6	MDB banknotes settings
6.1.2.6.1	Accepted
6.1.2.6.2	Exact change accepted
6.1.3	Virtual Credits
6.1.4	Beverage selection numbers
6.2	Price
6.2.1	Currency symbol
6.2.2	Overall beverage price
6.2.3	Beverages price
6.2.4	Free sale code
6.2.5	Price brackets management
6.2.6	Coffee level price
6.3	Cash action
7	Import/Export
7.1	Export EVA-DTS

OPTION NO.	MENU ITEM
7.1.1	Export file
7.1.2	Serial Port export
7.2	Videos
7.3	Images
7.4	Backup
7.5	Faults log
8	System
8.1	Development
8.1.1	Export Menu
8.1.2	Show log
8.1.3	Finger simulator tests
8.1.3.1	Finger simulator tests
8.1.3.2	Simulator test import/export
8.1.4	Show dmesg
8.1.5	Export logs
8.1.6	System Info
8.1.7	Import/Export SW translations
8.1.8	Export doses table
8.1.9	Export the machine database
8.1.10	Environment Variables
8.2	TECHNICAL FEATURES
8.2.1	Components test
8.2.2	Machine input verification
8.2.3	Output Test
8.2.4	Touch screen test
8.2.5	Emptying the boiler
8.2.6	Verification machine parameters
8.2.7	Complete selections
8.2.8	Automatic test
8.2.9	Reset to first Power On
8.2.10	Reboot system
8.3	Date/Time Settings
8.4	Languages
8.5	User profiles
8.6	Network
8.6.1	Wi-Fi
8.6.2	BLUETOOTH
8.8	Information
9	Connectivity
9.1	E-mail alerts
9.1.1	Settings
9.1.2	Events alert
9.1.3	Faults alert
10	Touchless Option
10.1	Saeco ProUp
10.1.1	Saeco ProUp Settings

8.4.2 Items description of the programming menu



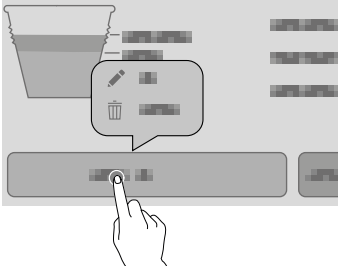

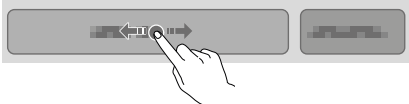
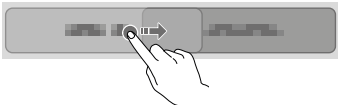
OPTION NO.	MENU ITEM	Description
0	Menu	This menu makes it possible to access all the configuration parameters of the machine.
1	Daily actions	Groups together all of the functions that are used on a daily or more frequent basis (washes, resetting the residue counters, etc.)
1.1	Washing/rinsing	Automatic washing and rinsing functions of the appliance's functional units (Cappuccino maker). Select the components that require washing.
1.2	Emptying the residue trays	Resets the counter that manages the "Residue full" warning when the solid residue tray is full.
2	Beverage settings	Settings for recipes, enabling products, ingredients, pre-brewing, etc.
2.1	Display	It is possible to change the order of the beverage categories and the layout of the beverages in the various categories. To change the order of the categories click on the arrows (up and down) of the category that you want to move. To change the layout of the beverages within a given category click on the "Change Beverage Layout" key of the category of beverages of which you want to change the layout. Select the layout of the selections from the default ones which are displayed in normal user mode (1x4, 2x4, 2x5,...). To make a selection available or unavailable when the appliance is in normal user mode, drag the selection icon from the available selections and vice versa.
2.2	Categories	Allows the selection categories to be created, modified or deleted. The selection categories are displayed during normal user mode and they allow the selections to be grouped by their beverage type (e.g. "milk-based beverages") The function allows: - A new category to be created  - A category to be duplicated  - A category to be modified  - A category to be deleted  - The available categories to be enabled/disabled. CREATING / MODIFYING A CATEGORY The name, description and icon of a category can be assigned or modified.
2.3	products	From the screen, it is possible to: - Create new beverages and associate a recipe  The software checks that there is compatibility between the recipe and appliance configuration (layout). If an incompatibility has been detected it is displayed  - Delete a beverage  - Duplicate a beverage

OPTION NO.	MENU ITEM	Description
		 <p>- Customise a beverage</p>  <p>CREATING / MODIFYING A BEVERAGE It is possible to:</p> <ul style="list-style-type: none"> - Assign/modify the name of beverages displayed during normal user mode. - Select which recipe to use for the preparation of the beverage. <p>By default, the appliance uses recipes for single drinks; for double selections (X2), recipes with adequate doses need to be created.</p> <p>The software checks that there is compatibility between the recipe and appliance configuration (layout). If</p>  <p>is displayed, it means an incompatibility has been detected.</p> <ul style="list-style-type: none"> - Change the image associated with the beverage; - tap the image to choose a new image. - Enable the option to prematurely stop a selection ("stop dispensing" function) - Associate a multimedia content playlist to be displayed whilst dispensing. - Dispense a test beverage.
2.3.1	Beverages displayed	Makes it possible to customise the beverages displayed.
2.3.2	Beverages available	Makes it possible to customise the beverages available in the machine.
2.3.3	Beverages not available	Makes it possible to customise the beverages not available in the machine because of the configuration.
2.4	Recipes	<p>It is possible to:</p> <ul style="list-style-type: none"> - Create a new recipe  <p>The new recipe is saved in the "not available" category. Then associate the recipe with the beverage. The software checks that there is compatibility between the recipe and appliance configuration (layout). If</p>  <p>it means an incompatibility has been detected</p> <ul style="list-style-type: none"> - Delete a recipe  <p>- Duplicate a recipe</p>  <p>- Customise a recipe</p>  <p>CREATING A NEW RECIPE The guided procedure allows a new recipe to be created. A screen is displayed where:</p> <ul style="list-style-type: none"> - A name can be assigned to the new recipe - Tap 

OPTION NO.	MENU ITEM	Description
		<p>and then "Add preparation" to add the products which make up the recipe (e.g. coffee, milk, etc.)</p> <p>The parameter screens vary according to the product added (espresso coffee, fresh milk, etc.)</p> <ul style="list-style-type: none"> - To add customisations tap  <p>and then "Add customisation"</p> <p>For every customisation it is possible to set various parameters.</p> <ul style="list-style-type: none"> - Save the settings and return to the main screen. <p>On the main screen of the recipe with "Test the recipe" it is possible to dispense a test selection in order to check the recipe created.</p> <p>After the test selection, the recipe can be modified.</p> <p>MODIFYING A RECIPE</p> <p>From the recipe screen, it is possible to:</p> <ul style="list-style-type: none"> - Change the name of a recipe <p>Other ingredients and/or customisations can be added to the recipe.</p> <p>From the recipe screen tap</p>  <p>to add other ingredients and/or customisations.</p> <p>To change the settings of individual ingredients (e.g. the amount of water, powder, etc.), tap the ingredient bar to open the context menu.</p>  <ul style="list-style-type: none"> - Tap "Modify" to change the parameters.  <ul style="list-style-type: none"> - Tap "Delete" to delete the ingredient.  <p>To move an ingredient before or after another ingredient, simply drag the bar of the ingredient.</p>  <p>For some products (e.g. milk) it is possible to enter their delivery at the same time.</p> 

OPTION NO.	MENU ITEM	Description
		 <p>After changing the parameters, save the settings and return to the main screen. "Test the recipe" on the main screen allows a test selection to be dispensed in order to check the modified recipe.</p> <p>BASIC COFFEE PARAMETERS It is possible to set:</p> <ul style="list-style-type: none"> - The name of the ingredient - The doses (water and powder) - Dispense a test beverage <p>For appliances with a payment system, it is possible to set the change in the price of the selection.</p> <p>BASIC MILK PARAMETERS It is possible to set:</p> <ul style="list-style-type: none"> - The name of the ingredient - The doses (milk) - Dispense a test beverage <p>BASIC HOT WATER PARAMETERS It is possible to set:</p> <ul style="list-style-type: none"> - The name of the ingredient - The doses (water) - Dispense a test beverage <p>ADVANCED COFFEE PARAMETERS MINIMUM QUANTITY OF BEVERAGE (in impulses)</p> <p>OFFSET TEMPERATURE This function makes it possible to regulate a possible increase/decrease of the coffee's temperature in the cup. It allows to lower or increase the temperature of the product on a range between -5 and +5.</p> <p>Double shot If active, this function performs double brewing of coffee for single drink dispensing.</p> <p>PRE-INFUSION TIME Sets the pre-infusion time before the actual infusion occurs.</p> <p>PRE-INFUSION DOSE Sets the quantity of water (in impulses) to be used during pre-infusion.</p> <p>ADVANCED MILK PARAMETERS AIR PWM PERCENTAGE Allows to regulate the quantity of cream in the cup (0% unfrothed milk, 100% completely frothed milk).</p>
2.4.1	Recipes in use	Makes it possible to customise the recipes of the beverages displayed in the machine.
2.4.2	Recipes available	Makes it possible to customise the recipes of the beverages available but not displayed in the machine.

OPTION NO.	MENU ITEM	Description
2.4.3	Recipes not available	Makes it possible to customise the recipes not available in the machine because of the configuration.
2.5	Containers	According to the machine layout, how the product containers have been arranged can be shown. Choose a container in order to: - Assign a name to the container. - Associate an ingredient to the container (Coffee beans, Coffee beans 2, fresh milk, ...) - Change the colour associated with the container.
3	Machine settings	This menu makes it possible to access the settings of the machine.
3.1	Machine Configuration	Makes it possible to access the configuration group database of the machine.
3.1.1	Selection of the configuration	Allows the appliance's group and individual configurations to be managed. A group of configurations contains multiple individual configurations (layout). Groups of configurations and individual configurations can be deleted and duplicated. When using a new configuration, you can decide whether to reset the statistical data, calibrations, and maintenance counters or not. Before uploading the configuration of another appliance (cloning), make sure that the two appliances' settings are compatible.
3.1.2	Backup and Restore	Backup Allows the machine settings to be saved as a backup file. RESTORE Allows the backed-up machine settings to be restored. The appliance can be restored to its: - Factory settings - Previously-saved custom settings. After having restored the settings from the configuration file, enable the configuration from the "Selection of the configuration" menu.
3.1.3	Import from a USB	Allows the new machine settings to be imported from a configuration file that has been saved onto a USB memory stick. The import function can be used to clone the settings of another appliance; make sure that the two appliances' settings are compatible.
3.1.4	Export via a USB	Allows the machine settings to be exported into a configuration file on a USB memory stick. The export function can be used to clone current settings onto another appliance; make sure that the two appliances' settings are compatible.
3.2	Configuration of the translation	
3.2.1	Edit Translations	The names of the beverages, recipes, containers and nutritional information, which are displayed on the screens, can be changed in the available languages. The programming menu strings cannot be changed.
3.3	Display settings	
3.3.1	Customising the interface graphics	Allows customisation of certain graphical elements of the user interface.
3.3.1.1	Edit	Allows some user interface graphics to be set, such as backgrounds, text size, colours, etc.
3.3.1.2	Select	Allows to choose the file with the custom graphics to apply to the user interface. The files uploaded via the "import" function will be displayed.
3.3.1.3	Import interface graphics	Allows the custom graphics files on the USB memory stick to be browsed through and selected, in order to be imported onto the appliance.
3.3.1.4	Export interface graphics customisation	Allows the custom graphics to be saved onto a USB memory stick.
3.3.2	GUI package	Allows a new template of the GUI package to be selected.

OPTION NO.	MENU ITEM	Description
3.3.3	General settings of the display	Enables/disables the display of: <ul style="list-style-type: none"> - The multimedia content available in normal user mode during dispensing. - The setting of the touchscreen's brightness; 100 sets the maximum brightness. - The display of the number of dispensing cycles completed since the appliance was switched on. - The price of the selections when operating normally (for models with a payment system). - Time and date. - The beverage preparation infusion time. - The screensaver; when enabled, you can enter when to activate the screensaver. Select whether to display a screensaver or a playlist.
3.3.4	Playlist	Allows playlists with entertainment content to be created and managed. A playlist contains videos and/or image sequences that are played whilst the selection is being dispensed. If a playlist only contains images, you can indicate after how long to show the next image. <p>Add videos or images to the playlist</p>  <p>Copy the playlist</p>  <p>Delete the playlist</p>  <p>A name must be assigned to a new playlist. The playlist contents can be played in the following modes: random</p>  <p>or cyclic</p> 
3.4	Input settings	The functional unit allows the operation of some of the appliance's sensors to be set.
3.4.1	Solid residues settings	Enables/disables the solid residue count that manages the "residue full" warning. The level of the residue trays can be checked from the appliance's status window.
3.5	Output settings	Allows the settings to be modified on actuators, espresso unit and lights.
3.5.1	Espresso settings	Pre-grinding: enables/disables the coffee grinder for the next selection. Pre-grinding reduces the preparation time of the next selection containing ground coffee. Pre-grinding affects the aroma of the next selection containing ground coffee.
3.5.2	Audio settings	Checks the settings of the built-in speakers.
3.6	Maintenance	Maintenance and rinse alerts.
3.6.1	Automatic rinse	The automatic rinse cycle programming of the appliance can be enabled/disabled. Programme the type of rinse to be performed on the day and time that has been set. Automatic rinse cycles can be added and removed. Automatic rinse cycles use hot water. Scalding hazard! Do not put your hands in the dispensing area. During the rinses, a message appears showing the progress of the operation.
3.6.2	Descaling settings	Allows to modify the hardness level of the water.

OPTION NO.	MENU ITEM	Description
3.6.3	Water filter settings	Allows to manage the water filter.
3.7	Other settings	<p>WATER MAIN Enables / disables the use of the water mains.</p> <p>EXTERNAL TANK Enables / disables the use of the external tank.</p> <p>ACCESS TO THE CLOSED-DOOR PROGRAMMING Enables/disables access to the programming menus when the door is closed.</p>
4	Information on the machine	
4.1	Failures	<p>The appliance has a number of sensors that keep the various functional units under control.</p> <p>When an anomaly is detected, the appliance displays the type of fault and it is (or part of it) put out of service.</p> <p>Detected faults are stored in specific counters.</p>
4.1.1	Current status	<p>Displays the faults found on the appliance.</p> <p>If there are no faults, the list will be empty.</p>
4.1.2	Fault history	<p>This function makes it possible to view a list of the fault history; the fault history contains the name of the fault with the date and time.</p> <p>With this function, the list of reported faults can be reset to zero.</p>
4.1.3	Event History	<p>This function allows the events reported by the appliance to be viewed and filtered.</p> <p>With this function, the list of reported events can be reset to zero.</p>
4.2	Statistics	Statistics and counters can be viewed and managed.
4.2.1	Display statistics	Displays the selection statistics (e.g. the number of deliveries carried out, time and date of the last delivery, etc.).
4.2.2	Reset statistics	Resets the stored statistics of the selections.
4.2.3	Show Audit	Displays the EVA-DTS beverage counters used for each dispensing type (Free vend, Sales, Test, etc.).
4.2.4	Beverage items numbers	Allows the selections to be numbered and match the selection number-beverage in the statistics.
4.2.5	EVA-DTS Customisation	Makes it possible to enable and therefore track specific events of the EVA-DTS protocol (not used at the moment).
4.3	Favourites menu	<p>The "favourites" are links with the functions frequently used.</p> <p>After having added a function to the "favourites," simply view the "favourites" and tap the function for quick access.</p>
4.3.1	Favourites list	<p>Displays all frequently used functions that have been saved as "favourites"</p> <p>Tap the function to access it.</p>
4.3.2	Eliminate favourites	<p>To remove a function from the "favourites" list, tap the function that you want to remove.</p> <p>To remove all the functions from the list of "favourites", tap "Delete all".</p>
4.4	Machine Number and Name	<p>Allows you to enter a numerical code and name that identifies the appliance.</p> <p>The code can be used to identify the appliance when analysing the statistics.</p>
4.5	Installation date	<p>Allows the date that the appliance was installed to be set. Tap "Modify" to set the date.</p> 

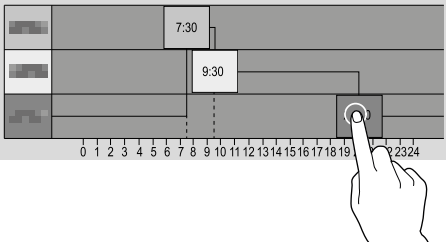
OPTION NO.	MENU ITEM	Description
4.6	Contacts Information	<p>Allows the contact information (name and phone number) of technical support to be entered that should be contacted in case of breakdown.</p> <p>This information will be displayed should a fault occur.</p> <p>It is possible to decide whether the information must be displayed with the faults that block the appliance or faults which do not block the appliance, or with faults which cannot be reset during normal user mode.</p> <p>Tap "Modify" to change the references.</p> 
5	Energy Saving mode	<p>The appliance's energy saving function can be enabled. Its parameters can also be modified and its time frames can be set.</p>
5.1	Energy Saving settings	<p>Enables/disables the energy saving function.</p> <p>The appliance can manage various energy saving profiles.</p> <p>Some of the parameters in every energy saving profile can be customised.</p> <p>"SOFT MODE" PROFILE</p> <p>This profile enables the energy saving mode after the appliance has a period of inactivity.</p> <p>When a selection is requested, the machine exits the energy saving mode.</p> <p>It is possible to:</p> <ul style="list-style-type: none"> - Set after how many minutes of appliance inactivity to activate the energy saving profile. - Set the maintenance temperature of the heating unit(s) in the energy saving mode. - Enable/disable the appliance's lighting. - Select the brightness level of the touchscreen from those that have been predefined. <p>"DEEP MODE" PROFILE</p> <p>This profile is active during the set time frames.</p> <p>During the set time frames, the heating unit temperature is lowered and the maintenance temperature is set.</p> <ul style="list-style-type: none"> - Set how many minutes to advance the heating of the heating unit(s) before the end of the time frame. For example 5 minutes: 5 minutes before the end of the time frame, the heating unit(s) heating cycle is activated in order to reach the operating temperature.
5.2	Energy Saving time frames	<p>Allows the time frames of the energy saving profiles to be set.</p> <ul style="list-style-type: none"> - Select the day for which the time frames will be set. - Tap the "Add" button, then the line of the profile in order to position a rectangle indicating the time. - Drag the rectangle to define the time exactly. <p>To delete a rectangle, tap the "Remove" button, then tap the rectangle to be deleted.</p> <p>Settings made for the entire week or a single day can be copied.</p> <p>Tap "Copy day profile" to be able to:</p> <ul style="list-style-type: none"> - Copy the time frames that have been set for a single day of the week; tap the day to set the energy saving mode to and then tap "paste day profile". <p>Copy the set up time frames for all days of the week; touch "paste daily profile to all days".</p> 
6	Payment Systems	

OPTION NO.	MENU ITEM	Description
6.1	Protocol	It is possible to decide which of the payment system protocols to enable and manage the relative functions. Some of the parameters, which are used in numerous payment systems, keep the set value even if the system type is changed.
6.1.1	GENERAL SETTINGS	<p>IMMEDIATE CHANGE Usually the amount for a selection is collected after the appliance sends the "Selection successful" signal. By enabling this function, which is disabled by default, the payment signal is sent at the start of the dispensing. The setting of this parameter is mandatory.</p> <p>POSITION OF DECIMAL POINT Sets the decimal point position, i.e.: 0: decimal point is disabled 1: XXX.X (one decimal digit after the point) 2: XX.XX (two decimal digits after the point) 3: X.XXX (three decimal digits after the point).</p> <p>DISPENSING TYPE This allows you to set the operating mode for multiple or single dispensing. With multiple dispensing, the change is not automatically dispensed at the conclusion of a successful dispensing, but the credit remains available for further dispensing. When the coin recovery button is pressed, the remaining credit will be returned if its value is less than the maximum change value.</p> <p>OBLIGATION TO BUY This enables/disables the return coins button before a product is dispensed. - ON: the change is returned after a product has been selected. - OFF: the change is returned immediately when the return coins button is pressed (the appliance works as a change machine).</p>
6.1.2	MDB	Payment system settings with MDB protocol.
6.1.2.1	Coin mechanism	<p>CREDIT PROGRAMMING (OVERPAY) It is possible to decide whether to: - Collect any credit in excess of the selection amount after a certain time expressed in seconds (parameter "deleted"). - Leave any credit in excess of the selection amount available for a subsequent selection (parameter "retained").</p> <p>OVERPAY TIMEOUT Makes it possible to set the time when the credit will be released if a selection hasn't been made. Max credit This function makes it possible to define the maximum credit for coins introduced which is accepted. Max change It is possible to set a limit for the total amount of change that the coin mechanism will pay when the return change button is pressed or after a single dispensed beverage. Any credit exceeding the amount that has been programmed with this function, will be collected.</p>
6.1.2.2	MDB coin settings	Management of coin settings.
6.1.2.2.1	Accepted	It is possible to define which of the coins recognised by the validator shall be accepted when the change giver tubes are full. For the coin/value correspondence, the configuration of the coin mechanism needs to be checked.
6.1.2.2.2	Exact change accepted	It is possible to define which coins recognised by the validator must be accepted when the machine is in "exact amount" mode. For the coin/value correspondence, the configuration of the coin mechanism needs to be checked.

OPTION NO.	MENU ITEM	Description
6.1.2.2.3	Returned	It is possible to define which coins among those available in the tubes shall be used for giving change. This parameter is only active with coin mechanisms that do not automatically choose which tube to use (Auto changer payout). For the coin/value correspondence, the configuration of the coin mechanism needs to be checked.
6.1.2.2.4	Vend token value	Value of the sales token. This is a token that is recognised and to which a sales price is associated. To request a drink, the value of the token must be greater than or equal to the price of the drink. Does not give change.
6.1.2.2.5	Exact change settings	Each algorithm checks a set of conditions (the amount of coins in the tubes or the empty or full status) in the tubes which is then used by the coin mechanism to give change. The "No change given" condition occurs when the tubes combined with the chosen algorithm have reached the minimum level of coins. For the sake of simplicity, the combination is described in reference to tubes A, B and C, where tube A receives the lower value coins and tube C the higher value coins. 0 = A or (B and C) 1 = A and B and C 2 = only A and B 3 = A and (B or C) 4 = only A 5 = only A or B (default) 6 = A or B or C 7 = only A or B 8 = only A or C 9 = only B and C 10 = only B 11 = only B or C 12 = only C For example: algorithm "6" will display the "No change given" message when all the tubes (A, B and C) are at the minimum level. Algorithm "4" will only display the "No change given" message when tube A (coin with the least value) has reached its minimum coin level.
6.1.2.3	Device without change	HIDE KEY CREDIT To protect the users' privacy, this function makes it possible to display "-----" instead of the credit remaining on the cashless system. UNDEFINED CREDIT ACCEPTANCE This function allows you to accept or reject the cashless payment systems (key or card) if the cashless system credit is not defined. CASH-SALE COMMANDS Enables/disables the cash-sale function. Makes it possible to show that the transactions made in cash took place through a cashless system. The available values are: - 0: the cash transactions are recorded as such (standard operation). - 1: the cash transactions are recorded as transactions performed by the first cashless system. - 2: the cash transactions are recorded as transactions performed by the second cashless system. REVALUE Enables / disables the banknotes reader exclusively for recharging the credit on the cashless system (key or card). SECOND CASHLESS Enable / disable the operation of a second cashless system.

OPTION NO.	MENU ITEM	Description
6.1.2.4	Check keys without cash	MDB cashless device, keys, credit, user group, price list.
6.1.2.5	Banknote acceptor	MDB bill acceptor settings.
6.1.2.6	MDB banknotes settings	Management of bill settings.
6.1.2.6.1	Accepted	It is possible to define which banknotes among those recognised by the reader must be accepted. In relation to the banknote/value correspondence, the configuration of the reader needs to be checked.
6.1.2.6.2	Exact change accepted	It is possible to define which banknotes among those recognised by the reader shall be accepted when the machine is in "exact amount" mode. For the banknote/value correspondence, the configuration of the reader needs to be checked.
6.1.3	Virtual Credits	As alternative to the MDB payment method, it allows beverages to be dispensed with virtual credits.
6.1.4	Beverage selection numbers	It is possible to assign an ID to every beverage.
6.2	Price	
6.2.1	Currency symbol	When the credit is displayed, this function allows the currency symbol to be set from those that have been predefined.
6.2.2	Overall beverage price	The appliance (depending on the payment method) can manage up to 4 different prices for each selection. The prices can be active according to the time frame that has been set (standard or promotional). The prices are grouped into 4 lists. For each of the 4 lists, the price can be set in a comprehensive manner (same price for all selections).
6.2.3	Beverages price	The appliance (depending on the payment method) can manage up to 4 different prices for each selection. The prices can be active according to the time frame that has been set (standard or promotional). The prices are grouped into 4 lists. For each of the 4 lists, the individual price can be set (for every single selection).
6.2.4	Free sale code	Enables/disables the free dispensing of one or more selections using a password. Set: - the password for one free dispensed beverage or - the password to dispense multiple selections for free

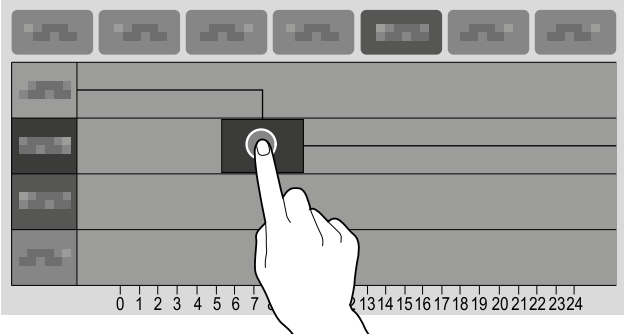
OPTION NO.	MENU ITEM	Description
6.2.5	Price brackets management	<p>Allows the time frames (standard or promotional) to be set for sales at differentiated prices.</p> <ul style="list-style-type: none"> - Tap the day you want to set the time frames for. - Tap the "Add" button, then the line of the time frame in order to position a rectangle indicating the time. - Drag the rectangle to define the time exactly. <p>To delete a rectangle, tap the "Remove" button, then tap the rectangle to be deleted.</p> <p>Settings made for the entire week or a single day can be copied.</p> <p>Tap "Copy day" to be able to:</p> <ul style="list-style-type: none"> - Copy the time frames that have been set for a single day of the week; tap the day to set the time frames and then tap "paste day". - Copy the time frames that have been set for all days of the week; tap "paste to all days". 
6.2.6	Coffee level price	Makes it possible to assign a delta price depending on the coffee level selected.
6.3	Cash action	Makes it possible to manage the coin mechanism, filling / emptying.
7	Import/Export	Includes all the export and import statistic functions, machine settings, graphics packages, etc.
7.1	Export EVA-DTS	
7.1.1	Export file	It allows the EVA-DTS statistics to be exported onto a USB memory stick.
7.1.2	Serial Port export	It allows the EVA-DTS statistics to be exported to a serial port. (Not supported).
7.2	Videos	<p>Allows videos to be imported/exported from the appliance via a USB memory stick.</p> <p>SUPPORTED VIDEO FORMATS</p> <ul style="list-style-type: none"> - MP4 codes H264 and 25 frames per second - AVI codes XVID, MPEG2 and 25 frames per second - MOV codes MPEG4 and 25 frames per second - 1200x800 maximum screensaver resolution - 640x480 entertainment video resolution. <p>The use of high-quality content will affect the overall performance of the appliance and use up memory space.</p> <p>Playing videos may require the authorisation of the copyright owner or other rights related to the content itself.</p> <p>Make sure to comply with the copyright laws that are in force in the country where the appliance is installed.</p>

OPTION NO.	MENU ITEM	Description
7.3	Images	<p>Allows images to be imported/exported from the appliance via a USB memory stick.</p> <p>SUPPORTED IMAGE FORMATS - JPG, PNG</p> <p>The use of high-quality content will affect the overall performance of the appliance and use up memory space.</p> <p>Showing images may require the authorisation of the copyright owner or other rights related to the content itself.</p> <p>Make sure to comply with the copyright laws that are in force in the country where the appliance is installed.</p>
7.4	Backup	<p>It allows a complete backup of the settings of the appliance to be exported/imported onto a USB memory stick.</p> <p>The configuration groups (with relative layouts), the customisations of the user interface, videos and images used for the playlists and prices are saved in the backup.</p> <p>The machine parameters and settings made can be exported and used on other appliances or after an update of the application software.</p> <p>The statistical data, the network settings, emails, machine name, installation date... are not saved.</p>
7.5	Faults log	<p>Exports the errors found on the machine into a log file.</p> <p>It is stored onto a USB memory stick.</p>
8	System	Development menu for debug, test, etc.
8.1	Development	
8.1.1	Export Menu	Allows a text file of the menu tree of the appliance software functions to be exported onto a USB memory stick.
8.1.2	Show log	<p>It allows the log file to be viewed.</p> <p>The log file is the sequential and chronological record of operations that have been carried out by the appliance.</p> <p>Enables events to be recorded in the log file from the "advanced functions" in the "development" menu.</p>
8.1.3	Finger simulator tests	Functions useful for the automatic tests.
8.1.3.1	Finger simulator tests	Functions useful for the automatic tests.
8.1.3.2	Simulator test import/export	Functions useful for the automatic tests.
8.1.4	Show dmesg	Shows the system dmesg (diagnostic message).
8.1.5	Export logs	<p>It allows the log file to be exported onto a USB memory stick.</p> <p>The log file is the sequential and chronological record of operations that have been carried out by the appliance.</p> <p>Enables events to be recorded in the log file from the "advanced functions" in the "development" menu.</p>
8.1.6	System Info	It contains the main information regarding the system, such as the used and available memory space,...
8.1.7	Import/Export SW translations	It makes it possible to import/export the user interface string translations via a USB memory stick.
8.1.8	Export doses table	It allows the settings of the recipes to be exported onto a USB memory stick.
8.1.9	Export the machine database	Allows the database containing machine information to be exported to a USB key.
8.1.10	Environment Variables	Sets application environment variables.
8.2	TECHNICAL FEATURES	
8.2.1	Components test	<p>Allows the appliance's main components to be checked.</p> <p>The components that can be checked are displayed.</p> <p>Choose the component to be checked.</p> <p>BREWING UNIT</p> <p>Starts moving the brewing unit.</p>

OPTION NO.	MENU ITEM	Description
		<p>Compressor The compressor is activated for a few seconds.</p> <p>PUMPS The pump selected is activated for a few seconds.</p> <p>During the test, hot water is dispensed: do not put your hands in the dispensing area.</p>
8.2.2	Machine input verification	<p>Displays the status of the appliance's various sensors and/or controls (probes, microswitches,...).</p> <p>For devices with ON/OFF functions, the status is shown using colour: green is used if the appliance is active/actuated, and red is used if it is disabled/not actuated.</p> <p>For the sensors, the detected value is displayed (e.g. the temperature).</p>
8.2.3	Output Test	<p>Allows the operation of the appliance's various components to be checked.</p> <p>The components that can be checked are displayed.</p> <p>Choose the component to be tested.</p> <p>For safety reasons, the tests must be carried out with the door closed.</p> <p>Press and hold down the component button to activate it and check that it is working.</p> <p>When the button is released, the component will be turned off.</p>
8.2.4	Touch screen test	<p>Allows the touch operation to be checked.</p> <p>Tap and drag your finger across the touchscreen.</p> <p>Each tap leaves a different-coloured trace.</p>
8.2.5	Emptying the boiler	The heating unit can be emptied.
8.2.6	Verification machine parameters	Not available.
8.2.7	Complete selections	Dispenses all the beverages for test purposes.
8.2.8	Automatic test	Acquires scripts that allow automatic testing.
8.2.9	Reset to first Power On	<p>Allows the appliance to be restored to its factory settings.</p> <p>All the statistical data, fault lists and settings will be lost.</p>
8.2.10	Reboot system	Programmes the system reboot.
8.3	Date/Time Settings	<p>The date and time are used to record events (for example faults,...), manage programmed washes and produce maintenance warnings.</p> <p>Set the current date and time.</p>
8.4	Languages	<p>The predefined language used to display messages on the user interface and in the menus can be changed.</p> <p>Some languages are available for the "change language" function.</p>
8.5	User profiles	<p>The use of some programming functions can be enabled/disabled via the access profiles.</p> <p>The access profile ensures that only the functions linked to it can be used.</p> <p>Each user profile has an access password.</p> <p>The default passwords are:</p> <ul style="list-style-type: none"> - Technician (4444), - User (1111) <p>Advanced programming functions must only be used by people with specific knowledge of the appliance (technical personnel) and hygiene regulations.</p> <p>It is possible to change the access password for each user profile from this function; tap the keypad icon to change the password.</p>
8.6	Network	The network configurations vary depending on the network selected and the network protections adopted.

OPTION NO.	MENU ITEM	Description
8.6.1	Wi-Fi	<p>It allows the Wi-Fi connection of the appliance to be enabled and configured. Enable the Wi-Fi connection to connect the appliance to a Wi-Fi network. The appliance supports the main Wi-Fi protection systems (cryptography). "Open" encryption does not guarantee any type of protection. By activating the Wi-Fi connection, the appliance displays the Wi-Fi networks available. Choose the name of the Wi-Fi network (SSID) to which to be connected; should the Wi-Fi network be hidden it is necessary to know the name (SSID) and enter it manually.</p> <p>The network parameters (such as the IP address,...) can either be:</p> <ul style="list-style-type: none"> - assigned automatically (DHCP) or - manually. <p>To automatically assign the network parameters, there must be a DHCP server on the network.</p> <p>The parameters relative to the protections and the access password to the Wi-Fi network must be set manually.</p> <p>The MAC address is a unique address assigned by the manufacturer that identifies the appliance's network card.</p> <p>The MAC address cannot be changed.</p>
8.6.2	BLUETOOTH	<p>It enables and configures the Bluetooth connection and allows short-range data exchange (a maximum of 10 metres) between the appliance and other devices. To connect to a Bluetooth device you need to:</p> <ul style="list-style-type: none"> - enter the identification of the appliance. - Make the appliance detectable when searching for Bluetooth devices. In detection mode, a wireless signal is transmitted which allows the appliance to be detected by other devices. - Enter the authentication code in order to be able to associate the Bluetooth device. <p>When a device can be detected, the pairing mode is also usually enabled. The linked devices are shown.</p> <p>From the menu it is possible to enable the connection with Blue Manager, an application which permits the downloading of statistics via Bluetooth using the EVOCA proprietary application BlueRed Manager available on Play Store.</p>
8.8	Information	Allows all of the information regarding the appliance's software to be viewed (version, graphic theme used, machine configuration, etc.).
9	Connectivity	
9.1	E-mail alerts	<p>The appliance is able to send notifications (via email) regarding events and faults. In order to send email notifications, an active network connection is needed. The appliance sends notifications via email. It is impossible to receive emails on the appliance.</p>

OPTION NO.	MENU ITEM	Description
9.1.1	Settings	<p>Enable the function so that you can set the parameters for sending emails, in addition to the email addresses of notification recipients.</p> <p>The parameters vary depending on the email server used (supplier of email services).</p> <p>The appliance provides a set of preconfigured parameters for the major email service providers on the internet.</p> <p>It is possible to manually enter the email parameters for the other internet email service providers or for email servers on LAN networks (custom preset).</p> <p>For email servers on a LAN network, contact your network administrator (system administrator) to find out the appropriate email parameters.</p> <p>For internet email service providers, you need to contact the email service provider support or support services in order to have access to the appropriate email parameters.</p> <p>You can enter and delete the email addresses that you intend to send notifications to.</p> <p>After setting the parameters, you can send a test email to check that it has been configured correctly.</p>
9.1.2	Events alert	Enable the events for which you want to receive notifications (e.g. access to menus, sanitisation operations, etc.).
9.1.3	Faults alert	Enable the faults you want to receive notifications for (e.g. no coffee, no water, etc.).
10	Touchless Option	Menu that the permits the use of the machine remotely.
10.1	Saeco ProUp	Mobile app which is the property of EVOCA.
10.1.1	Saeco ProUp Settings	From this page it is possible to enable the connection of the machine with Saeco Pro Up, display the associated ID and manage the certificate.

8.5 Setting user profiles passwords

The use of some programming functions can be enabled/disabled via the access profiles.

The access profile ensures that only the functions linked to it can be used.

Each user profile has a default access password.

The user profiles are:

- User
- Technician

 Advanced programming functions must only be used by people with specific knowledge of the appliance (technical personnel) and hygiene regulations.

It is possible to change the access password for each user profile from this function. tap the keypad icon to change the password.

9 OPERATION AND USE

 The use by children older than 8 years or by persons with reduced physical, mental or sensory abilities or with lack of experience and skills is allowed, provided that they are supervised or instructed on how to use the appliance correctly and that they understand the hazards involved.

 Children must not play with the appliance. Children must not carry out any cleaning and maintenance operations without being monitored.

 For hygienic reasons, after the machine has not been used for a long time, it is recommended to thoroughly rinse the circuit.

9.1 Turning on the Machine

 Connection to the power supply should be carried out exclusively by the service provider!

 Ensure that the upper lid is always locked.

Before turning on the machine, ensure that the plug is correctly inserted in the power socket. To turn on the machine, move the power button on the back of the machine to "I".

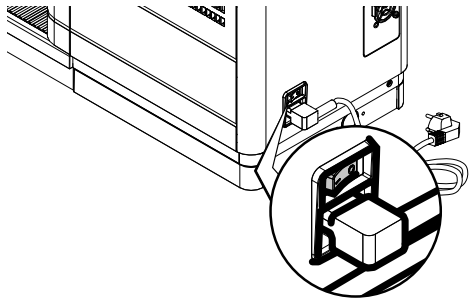

 Once warm-up has been completed, the machine performs a rinse cycle of the internal circuits. A small amount of hot water is dispensed during this process. Wait for this cycle to be completed.

9.2 Warm-up and Rinsing

Upon start-up, the machine activates the warm-up phase. Wait until it is completed.

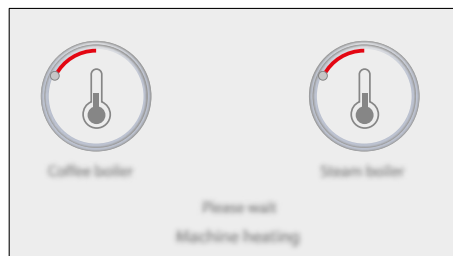

 The bars advance and show that the machine is warming up the system.

Once warm-up has been completed, the machine performs a rinse cycle of the internal circuits.

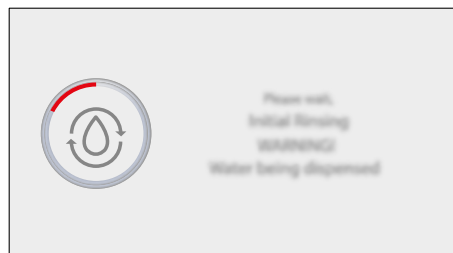

 The progress bar indicates that the machine is performing the rinse cycle of the system.

A small amount of water is dispensed. Wait until the cycle is completed.

When the product selection screen appears, the machine is ready to use.

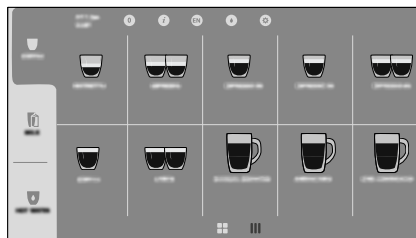

 If the machine is used for the first time or after a long period of inactivity, contact the Service Provider to start it up.

9.3 Rinse/Self-Cleaning Cycle

The cycle permits the internal circuits to be rinsed with fresh water. The cycle is carried out:

For the coffee circuit

- When the machine is started;
- During the Stand-by preparation phase if coffee was dispensed when the power is turned on;
- After waking up from stand-by;

For the milk circuit (*only versions M).

- When the machine is started if milk was dispensed when it was turned on previously;
- When waking up after stand-by if at least one milk product was dispensed before going into stand-by;
- After a specific period of time following the last milk product;

A small amount of water will be dispensed to rinse and heat all the machine parts.

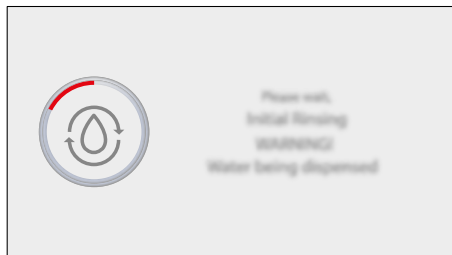

Wait for this cycle to be completed automatically.

9.4 Energy Saving mode

The machine can be set to energy saving mode. If set to energy saving mode, after a certain period of inactivity since the last delivery, the machine turns off automatically. This period of time is set by the operator in the programming menu.

 During the turn-off phase, the machine will perform a rinse cycle if a coffee product has been brewed.

 Time can be programmed according to your needs (see instructions in chapter "Programming Menu").

To restart the machine simply tap the control panel; the machine will rinse the coffee circuit; the machine will also rinse the milk circuit if at least one milk product was dispensed before going into stand-by;

9.5 Dispensing beverages coffee only

Insert the cup or glass under the dispenser.

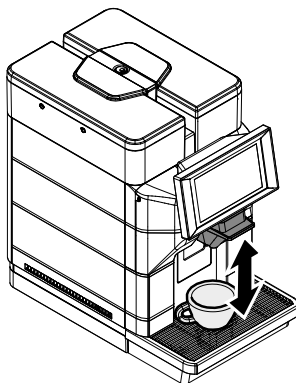

To dispense a coffee beverage touch the icon of the coffee beverage desired. If the coffee beverages are not visible on the beverage selection screen, tap the "COFFEE" icon on the left of the beverage selection screen in the control column and subsequently tap the icon of the coffee beverage desired.









Start the dispensing cycle. Once the prebrewing cycle has been completed, coffee begins to come out of the dispensing spout. Coffee brewing stops automatically when the preset level is reached. It is in any case possible to interrupt the dispensing by tapping the "STOP" icon.



9.6 Dispensing beverages with milk

(*only versions M).

-  To correctly use and achieve an optimal result of the milk product in cup the silicone suction hose supplied must be used including the metal reducer located at its end.
 -  Do not tamper with the hose by modifying the length and removing the metal reducer located at its end.
 -  Clean the suction hose externally with a damp cloth. This way, all parts will be perfectly clean and free of any milk residue.
 -  To dispense beverages with milk, the cappuccino maker must be installed in the machine.
-  To ensure better results when preparing milk, use cold milk.
 -  Use cold ($\sim 5^{\circ}\text{C}$ / 41°F) milk with a protein content of at least 3% to ensure top-quality beverages. Whole milk, skimmed milk, soy milk or lactose-free milk may be used depending on individual taste.

Insert the clean tube directly into the milk container.

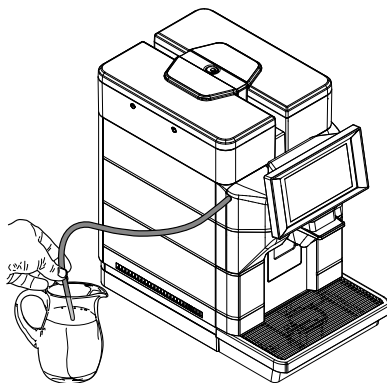

Insert the cup or glass under the dispenser.



To dispense a beverage with milk tap the icon of the beverage with milk desired. If the beverages with milk are not visible on the beverage selection screen, tap the "MILK" icon on the left of the beverage selection screen in the control column and subsequently tap the icon of the beverage with milk desired.



⚠ Danger of burning! Dispensing may be preceded by small jets of hot water and steam.

The machine needs time to preheat. Once the warm-up is completed, the machine starts to dispense the beverage selected. The beverage stops dispensing automatically when the level set is reached; it is in any case possible to interrupt the dispensing by tapping the "STOP" icon.



Remove the container and clean it if necessary.

👉 Always remember to store milk in the fridge when not used.

⚠ After a preset period of time following the last beverage with milk dispensing, the machine automatically rinses the milk circuit.

9.7 Hot Water Dispensing

Insert the cup or glass under the dispenser.

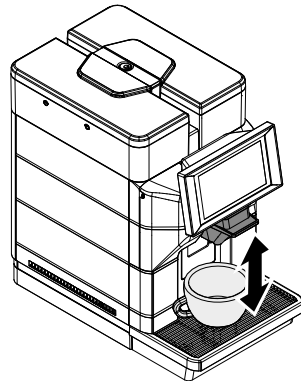

To dispense the "HOT WATER" beverage tap the "HOT WATER" beverage icon. If the "HOT WATER" beverages are not visible on the beverage selection screen, tap the "HOT WATER" icon on the left of the beverage selection screen in the control column and subsequently tap the icon of the "HOT WATER" beverage desired.



 **Danger** of burning!
Dispensing may be preceded by small jets of hot water and steam.

Start the dispensing cycle. The hot water starts to come out of the dispenser. The hot water stops dispensing automatically when the level set is reached; it is in any case possible to interrupt the dispensing by tapping the "STOP" icon.



9.8 Using the Machine with Credits

 This option can be enabled or disabled by the service provider.

The machine is designed to manage beverage brewing by means of a credit system. the same number of products can be dispensed as there are credits inserted by the operator. When the credits counter reaches zero, all beverages including milk and water are prevented. The available credit is displayed in the "ready for use" screen.

 Hot water and milk do not decrease the credits, but if the credit level reaches zero all beverages are prevented.

Each service provider decides independently how to manage the granting and recharging of credits to allow the machine to be used.

9.9 Emptying the coffee grounds drawer and drip tray

 This operation must be performed with the machine turned on and/or in stand-by mode.

The machine notifies when the residue collector has reached maximum capacity if that is set in the programming. The first notification, if preset in the programming, notifies the user that the residue collector drawer must be emptied and the machine still permits the dispensing of coffee. A new notification is added to the status panel.



If the residue is not emptied after the first notification, the machine allows the dispensing of beverages containing coffee until the maximum capacity is reached. Once the threshold is reached the machine disables all the beverages containing coffee and a new notification is added to the status panel.



In this case, the machine does not allow beverages containing coffee to be dispensed. To be able to dispense beverages containing coffee, it is mandatory that the coffee residue collector drawer be emptied. Extract the drip tray and the coffee grounds drawer.

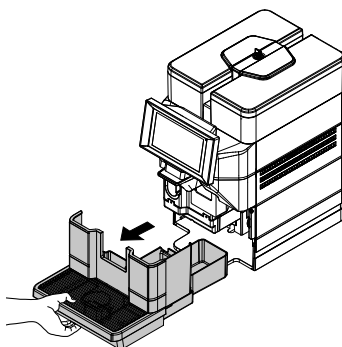

Raise the coffee grounds drawer.

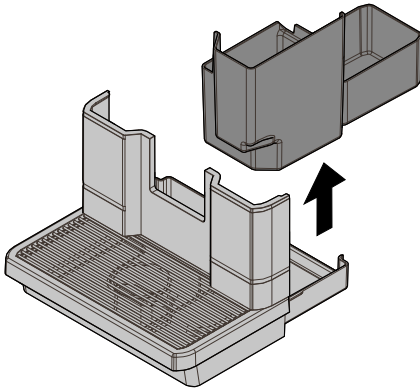

Empty the coffee grounds drawer and the drip tray.

 Liquids and coffee grounds must be disposed of separately, as appropriate.

Insert the residue collector drawer and the drip tray into the machine.

 If the drip tray is inserted without the coffee grounds drawer, the machine will not dispense products.

After having inserted them the machine is ready to be used and the coffee beverages can once again be dispensed.

9.10 "Touchless option"

The machine is set up to use a Bluetooth connection. The Bluetooth connection must be enabled through the programming menu, "Touchless Option" item, "Saeco ProUp" sub-item, "Saeco ProUp Settings" sub-sub-item. Refer to the "Description Items of the Programming Menu" of the "Programming Menu" chapter to display the description of the commands available.

When BT has been activated appears, the relative logo appears in the easy-to-use screen in the top right with the machine identification if set.

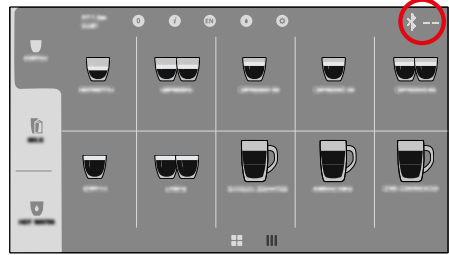

The BT makes it possible:

- To make selections remotely through the "Saeco Pro Up" app, also without registration. The app can be downloaded by framing the following QR code.



- Set the machine to operate credits through the "Saeco Pro Up" portal. The dedicated manual is available on the eCommerce EVOCA site. Following is the link to the eCommerce EVOCA site. <https://ecommerce.evocagroup.com/> The site can be accessed also by framing the following QR code.



- Perform the authentication procedure.
- Select the Saeco brand.
- Select "Search".
- Select "Documents".
- Select "Manuals kit" in the "Document type" box.
- Enter "Magic" in the "Model Description" box.

- Press the "Search" key.
- Click on the following icon:





- Select the dedicated manual.
- Order and/or load the machine credits from the "Saeco Pro Up" app, if logged with registered and enabled user.
- Make the adjustment of the technical setting directly from "Saeco Pro Up" app if logged with registered and enabled user.

 For any technical maintenance operation, it is mandatory to power the machine off.

10 CLEANING AND MAINTENANCE

 Before performing any maintenance and/or cleaning operation, unplug the power cord.

 The Manufacturer is not liable for damage or malfunctions caused by a wrong or lack of maintenance.

 Avoid using chlorine-based tablets so as to prevent oxidation phenomena inside the appliance.

10.1 General Notes for Correct Operation

 Non-removable components and the machine itself must be cleaned, when not differently specified, only by using cold or lukewarm water, with a non-abrasive sponge and a damp cloth.

 Never use direct jets of water onto the appliance and/or its components.

Periodic maintenance and cleaning will keep the machine in good working order for a longer time and ensure compliance with basic hygienic standards.

Follow the instructions and timing indicated in the "MAINTENANCE SCHEDULE" to ensure correct operation of the appliance.

10.2 Cleaning and Scheduled Maintenance

 All parts requiring cleaning are easily accessible, so no tools are needed.

 All parts must be washed with lukewarm water only and without using detergents or solvents that could change their shape or performance.

 All removable parts cannot be washed in the dishwasher.

 Do not clean the electric parts with wet cloths and/or with degreasing detergents. Remove any dust residues with a jet of dry compressed air or with an antistatic cloth.

10.2.1 Maintenance Schedule

Operation to be carried out	A	B	C	D	E
Drip tray	-	X	-	-	-
Emptying and cleaning the coffee grounds drawer	X	-	-	-	-
Cappuccinatore quick clean	X	-	-	-	-
Thorough cleaning of Cappuccino maker with detergent	-	X	-	-	-
Thorough cleaning of the Cappuccino maker dispensing nozzles	-	-	X	-	-
Thorough cleaning of Cappuccino maker - complete disassembly	-	-	-	X	-
Water tank cleaning	-	-	X	-	-
Brew group cleaning	-	-	-	X	-
Brew group lubrication	-	-	-	-	X
Coffee bean hopper cleaning	-	-	-	-	X
Cleaning coffee dispenser container	-	-	-	-	X
Descaling	X	-	-	-	-

A When an alert is shown

B Daily

C Every 48 hours

D Weekly

E Every month or 500 brewing cycles

 The machine and its parts should in any case be cleaned every week.

 The appliance and its parts should be cleaned and washed following a period of inactivity.

10.2.2 Cleaning the drip tray and coffee grounds drawer

The coffee grounds drawer is to be emptied and cleaned whenever indicated by the machine. However, it is recommended to empty it daily. To carry out this operation, see section "Emptying the coffee grounds drawer and drip tray".

In any case, whenever maintenance of the machine is carried out, it is suggested you remove and clean the coffee grounds drawer.

At this time, it is also advisable to clean the cup holder grills.

10.2.3 Cleaning the Water Tank

 For M2+ and B2+ versions, these operations must be carried out with the machine switched off.

After unlocking the lid, lift and remove it. (* only versions M2, M2+, B2 and B2+).

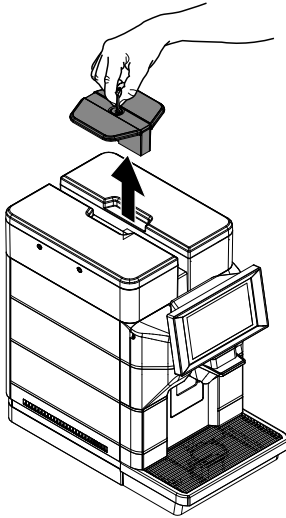

Remove the lid from the water tank.

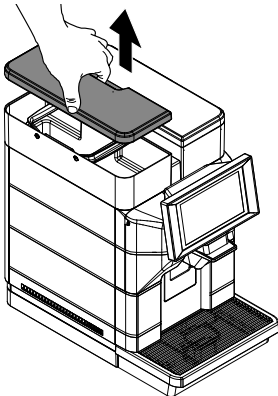

Remove the tank; lift it using the inside handles.

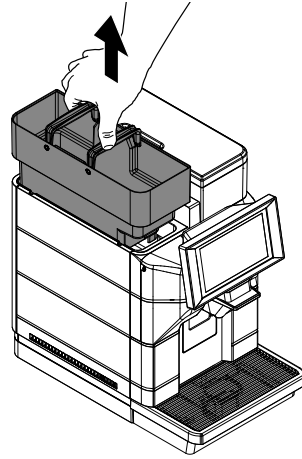

Use a non-abrasive detergent to wash it, rinse with fresh water and dry carefully.

10.2.4 Cappuccinatore quick clean

(*only versions M).

 After a preset period of time following the last beverage with milk dispensing, the machine automatically rinses the milk circuit.

This rinse can also be performed manually from the user menu as indicated below, but the operation does not have to be done after every beverage with milk since the machine will do it automatically after a few minutes.

Display in the status panel the available rinse functions.



Select the rinse of the cappuccino maker. Confirm the rinse. The machine dispenses a quantity of water sufficient to rinse the milk circuit. The following screen is displayed:

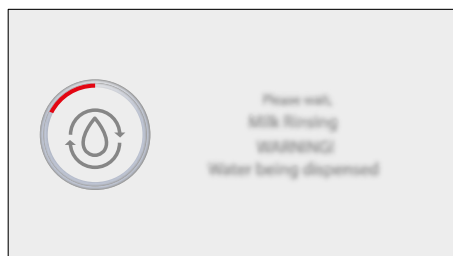

⚠ Danger of burning!
Dispensing may be preceded by small jets of hot water.

This function allows the machine to maintain system functionality, but under no circumstance should it be considered sufficient as the only method for cleaning the milk circuit. Wait until the cycle stops automatically. The machine will go back to the normal operating cycle.

10.2.5 Thorough cleaning of Cappuccino maker with detergent

(*only versions M).

Once a day thoroughly clean all the components of the cappuccino maker using the Saeco detergent. The Saeco detergent may be purchased at your local dealer or at authorised service centres.

⚠ Failure to thoroughly clean the cappuccino maker with detergent can cause potentially harmful bacteria to spread.

⚠ Danger of burning!
Dispensing may be preceded by small jets of hot water.

Access the programming of the machine as described in the paragraph "Access to the programming menus". Tap the "menu" icon to view the appliance's menu functions.



Select "Daily actions". Select "Washing/rinsing". Select the washing of the cappuccino maker. Select "Washing".

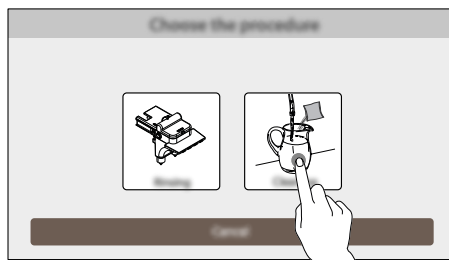

Confirm the process. The machine summarizes on the display all the phases to be performed for the washing step-by-step. For example, the phases are the following:

Fill the water tank. (Only if the appliance is not connected or set to the water mains).

Pour a sachet of solution into a container with 1/2 (half) litre of fresh drinking water.

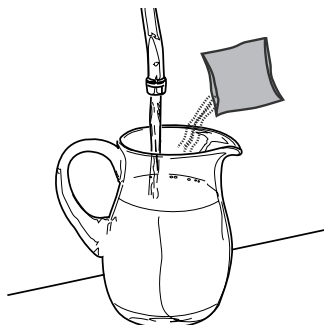

Insert the clean tube directly into the container.

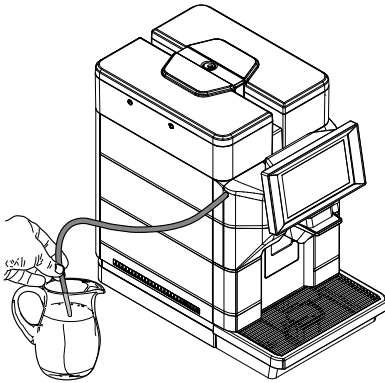

Position an empty container with a capacity of at least 1 litre under the dispenser.

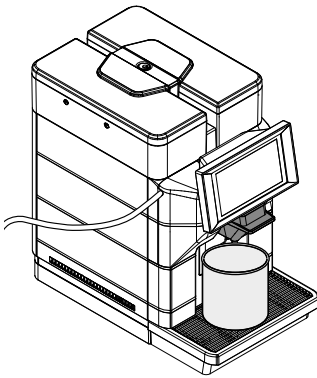

The machine runs a washing cycle of the cappuccino maker with detergent. Wait until the cycle stops automatically. The following screen is displayed:

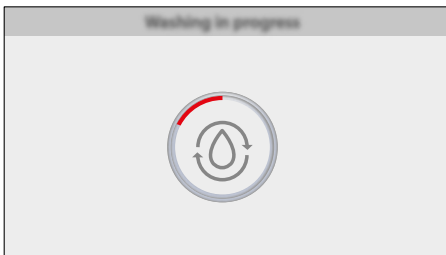

⚠ Do not drink the solution dispensed during this procedure. The solution must be disposed of.

Wash the container used for the solution thoroughly and fill it with 1/2 (half) litre of fresh drinking water which will be used for rinsing. Insert the suction hose into the container placed under the dispensing spout. Reposition the empty container under the dispenser.

The machine performs a Cappuccinatore rinse cycle. Wait until the cycle stops automatically. The machine will return to the "Washing/rinsing" menu. Remove the containers.

10.2.6 Thorough cleaning of the Cappuccino maker dispensing nozzles

(*only versions M).

Every 48 hours disassemble the dispensing nozzles of the cappuccino maker and thoroughly clean them.

Failure to clean can compromise the correct operation of the machine.

👉 Below please find how to disassemble and wash the nozzles.

Remove the aesthetic cover.

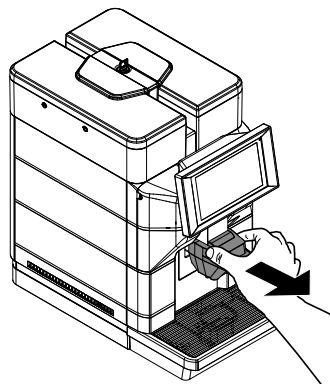

Remove the two dispensing nozzles as shown in the figure.

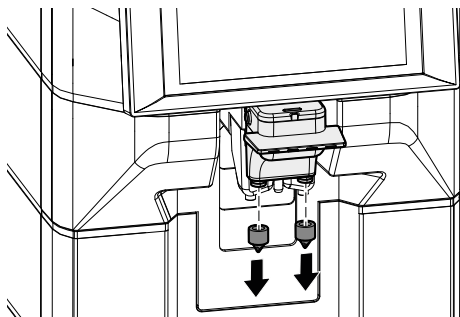

Wash the nozzles under running water pressing them lightly. Make sure any milk deposits/residues are removed. After washing, reassemble the parts following the same procedure used for disassembly, but in reverse order.

10.2.7 Thorough cleaning of Cappuccino maker - complete disassembly

(*only versions M).

Completely disassemble the cappuccino maker weekly to thoroughly clean all the components. Failure to clean can compromise the correct operation of the machine.

 The steps below show how to remove and clean the Cappuccinatore.

Remove the aesthetic cover.

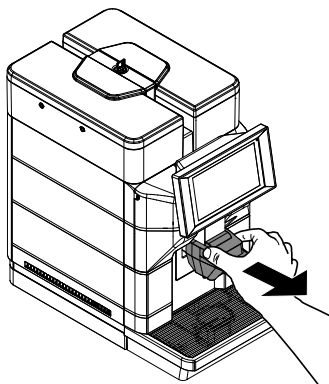

Push the button on the left side and remove the Cappuccinatore.

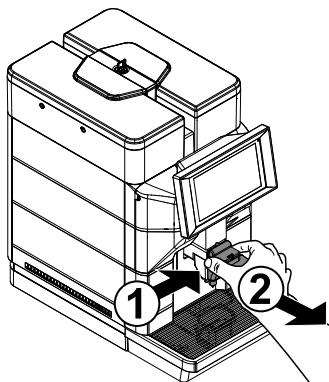

Remove the cover of the cappuccino maker.

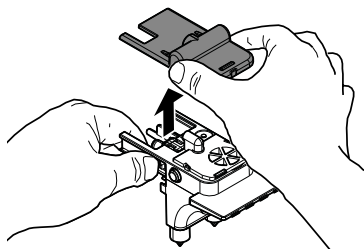

Remove the upper seal of the cappuccino maker.

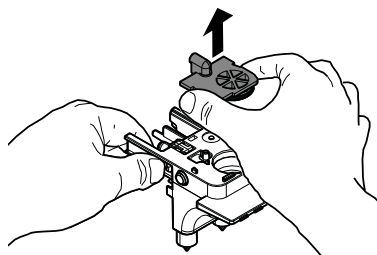

Remove the valve from the Cappuccinatore.

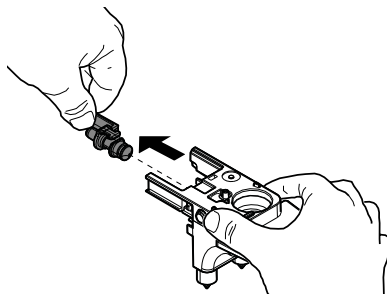

Remove the lower cover of the cappuccino maker.

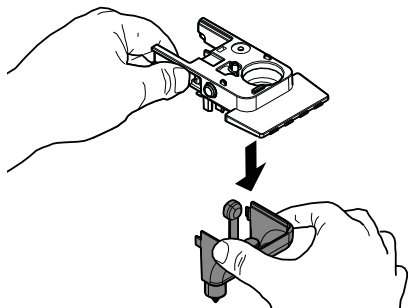

Disassemble all the parts of the lower cover of the cappuccino maker as shown in the figure.

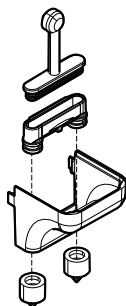

Wash the parts under running water. Make sure any milk deposits/residues are removed. After washing, reassemble the parts following the same procedure used for disassembly, but in reverse order.

⚠ Make sure to insert the milk distribution hose into the lower part of the cappuccino maker before replacing the lower cover of the cappuccino maker.

☞ After washing and reassembling the Cappuccinatore, it can be installed back in the machine.

10.2.8 Quick cleaning of the coffee unit

⚠ The coffee circuit must be rinsed quickly to guarantee optimal hygiene.

⚠ Danger of burning! Dispensing may be preceded by small jets of hot water.

Display in the status panel the available rinse functions.



Select the rinse of the coffee unit. Confirm the rinse. The machine dispenses a sufficient quantity of water to rinse the coffee circuit. The following screen is displayed:

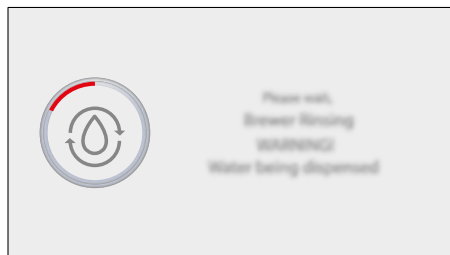

This function allows the machine to maintain optimal hygiene and service conditions, but under no circumstance should it be considered sufficient as the only method for cleaning the coffee circuit. Wait until the cycle stops automatically. The machine will go back to the normal operating cycle.

10.2.9 Thorough cleaning coffee unit with "degreasing tablets".

Besides weekly cleaning, we recommend performing a cleaning cycle with "Coffee Oil Remover" after approximately 200 cups of coffee or once a month.

This operation completes the maintenance process for the brew group. The "Degreasing tablets" for cleaning the coffee unit and the maintenance products can be purchased from your local dealer or the authorised support centres.

 The "Coffee Oil Remover" system has no descaling properties. For descaling, use the Saeco descaling solution and follow the procedure described in the "Descaling" chapter.

The wash cycle cannot be interrupted. Do not leave the machine unattended during this operation.

Access the programming of the machine as described in the paragraph "Access to the programming menus". Tap the "menu" icon to view the appliance's menu functions.



Select "Daily actions". Select "Washing/rinsing". Select the washing of the coffee unit. Select "Washing".

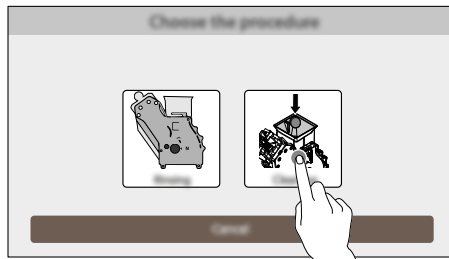

Confirm the process.

 If this option is confirmed, the cycle must be completed.

The machine summarizes on the display all the phases to be performed for the washing step-by-step. For example, the phases are the following:

Fill the water tank. (Only if the appliance is not connected or set to the water mains).

Remove the drip tray and the coffee grounds drawer.

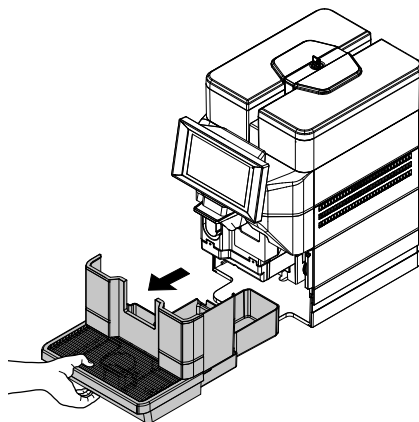

Empty the coffee grounds drawer and the drip tray.

Remove the screw preventing accidental opening of the service compartment flap. (* 120V USA version only).

Position the dispenser in the high position. Place an empty container under the dispenser.

Open the service door.

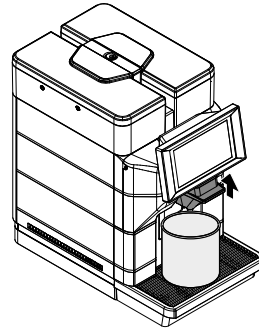
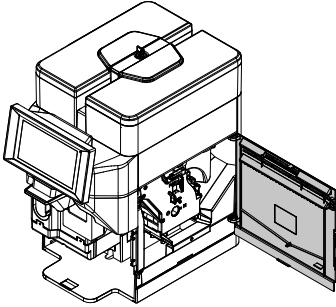

Remove the brew group by pulling it by the handle and pressing the «PUSH» button.

The machine runs the washing cycles of the coffee unit with degreasing tablet. Wait for the cycles to finish automatically. The following screen is displayed:

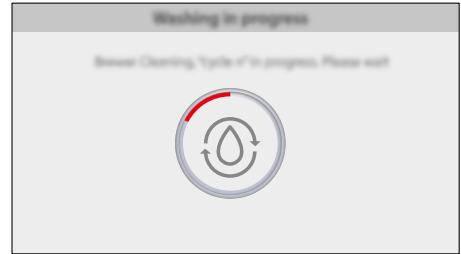
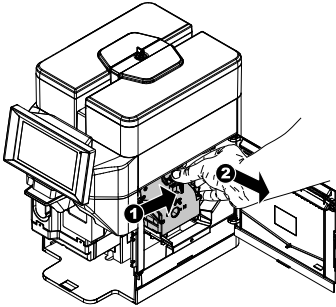

Place the cleaning tablet in the brew group and refit the group in the machine, making sure that all the components have been inserted and that the door is closed.

The cycles are completed automatically by the machine.

Re-insert the screw preventing accidental opening of the service compartment flap. (* 120V USA version only).

⚠ Do not drink the solution dispensed during this procedure. The solution must be disposed of.

👉 At the end of the cycles, the machine returns to the normal operating cycle after running the rinse cycle.

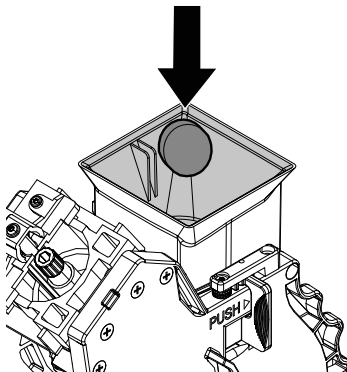

 It is recommended to remove the group and wash it under fresh running water.

 Ensure that the brew group is completely dry before putting it back into the machine.

10.2.10 Manual Cleaning of the Brew Group

The brew group should be cleaned whenever the coffee bean hopper is filled, or at least once a week. Turn off the machine by switching the power button to the "O" position and remove the plug from the socket. Remove the drip tray and the coffee grounds drawer.

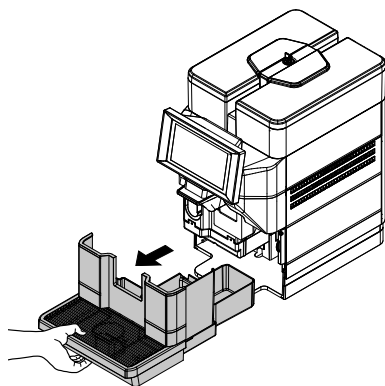

Remove the screw preventing accidental opening of the service compartment flap. (* 120V USA version only).

Open the service door.

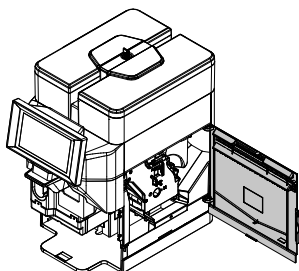

Remove the brew group by pulling it by the handle and pressing the «PUSH» button.

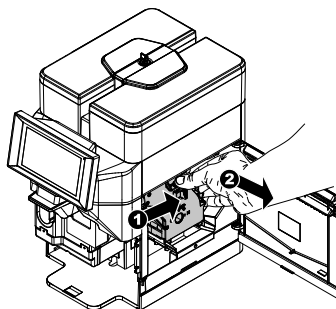

The brew group must be washed with lukewarm water only. Do not use any detergent. Wash the brew group with lukewarm water; carefully wash the upper filter. Before placing the brew group in its seat, ensure that there is no water left in the brewing chamber.

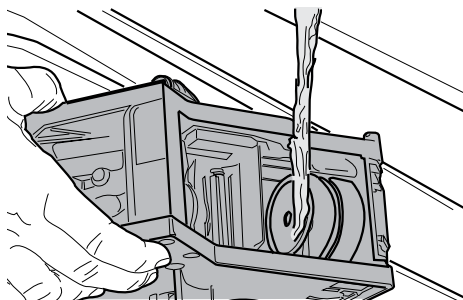

Clean the inside of the machine with a damp cloth.

Make sure that the brew group is in the off position. The two reference marks must match.

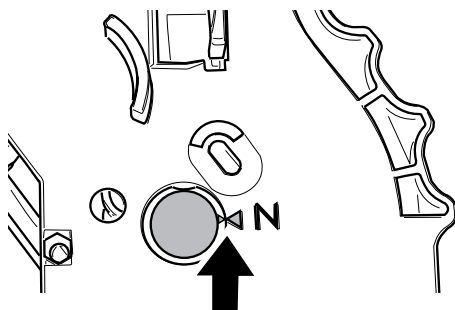

If they do not match, proceed as described below:

Ensure that the lever is in contact with the brew group base.

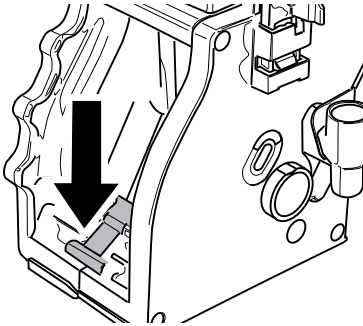

Make sure that the hook which locks the brew group is in the correct position. Firmly press the "PUSH" button to check its position.

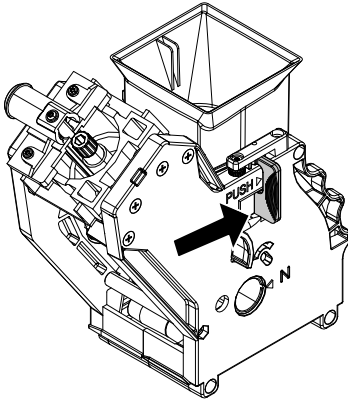

Insert the brew group into its seat again until it locks into place **WITHOUT** pressing the "PUSH" button.

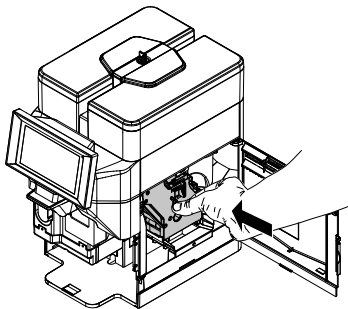

⚠ Check the correct blocking of the brew group in the housing, pulling it toward the exterior.

Close the service door.

Re-insert the screw preventing accidental opening of the service compartment flap. (* 120V USA version only).

Insert the coffee grounds drawer and the drip tray.

10.2.11 Brew group lubrication

Lubricate the brew group after approximately 500 cups of coffee or once a month. The grease for lubricating the coffee unit and the relative accessories can be purchased from your local dealer or the authorised support centres.

Before lubricating the coffee unit, clean it under running water as explained in the chapter "Manual cleaning of the coffee unit".

Lubricate the brew group guides using Saeco grease only.

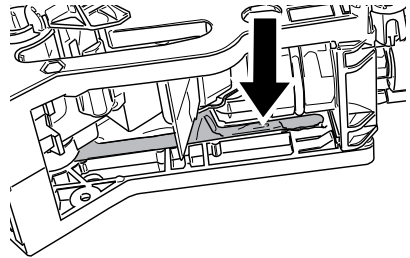

Apply the grease evenly on both side guides.

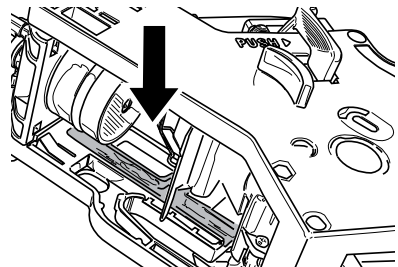

Lubricate the shaft too.

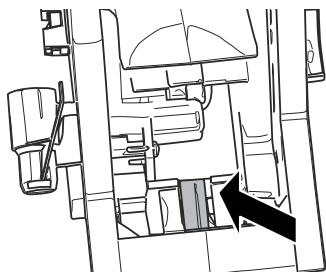
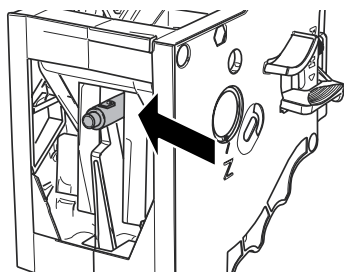

Insert the brew group into its seat again until it locks into place **WITHOUT** pressing the "PUSH" button.

⚠ Check the correct blocking of the brew group in the housing, pulling it toward the exterior.

Close the service door.

Re-insert the screw preventing accidental opening of the service compartment flap. (* 120V USA version only).

Insert the coffee grounds drawer and the drip tray.

10.2.12 Cleaning coffee dispenser container

Clean the coffee dispenser container after about 500 deliveries or once a month. Below please find how to disassemble the container:

Remove the aesthetic cover.

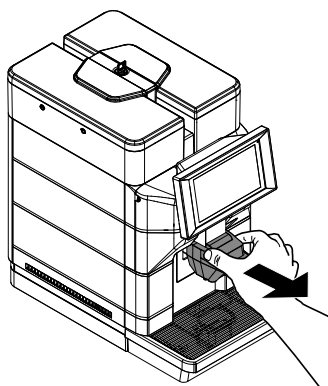

Push the button on the left side and remove the Cappuccinatore. (*only versions M).

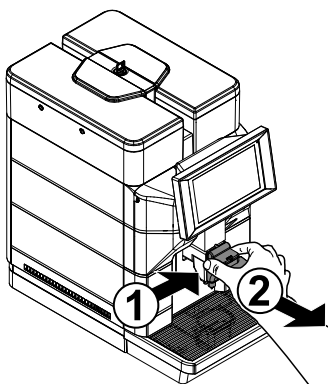

Remove the coffee dispenser container unit.

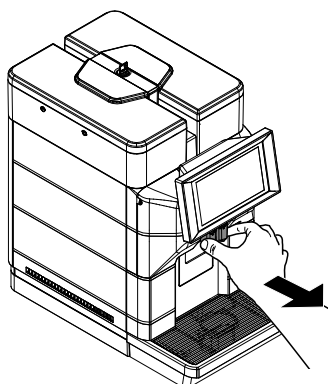

Press the sides of the coffee dispenser container unit to extract the water dispenser.

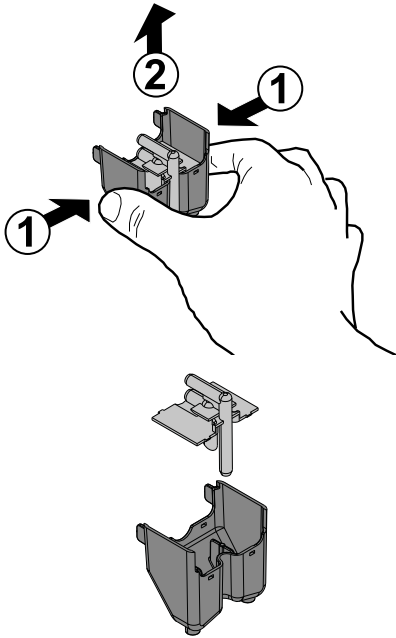

Wash the parts under running water. Ensure that any deposits/fouling have been removed and that the ducts are clean.

After washing, reassemble the parts following the same procedure used for disassembly, but in reverse order.

10.2.13 Descaling

Limescale is a natural part of the water used for machine operation. It needs to be removed regularly as it may clog the water and coffee circuit of your appliance. The machine indicates on the display when descaling is required.

Just follow the steps described below. This operation needs to be carried out before the appliance stops working properly, as in this case repair is not covered by warranty. The descaling and maintenance products can be purchased from your local dealer or the authorised support centres.

⚠ Never drink the descaling solution.

⚠ Never use vinegar as a descaling solution.

⚠ Before inserting the descaler, remove the antiscala filter, if present.

Access the programming of the machine as described in the paragraph "Access to the programming menus". Tap the "menu" icon to view the appliance's menu functions.



Select "Daily actions". Select "Washing/rinsing". Select descaling.

The machine summarizes on the display all the phases to be performed for the descaling step-by-step. For example, the phases are the following:

Remove the protection cover as described in section "Opening the Upper Lid". (only versions M2, M2+, B2 and B2+).

Remove the lid from the water tank.

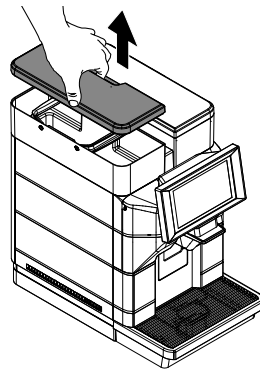

Reinsert the cap into the water tank. (Only if the appliance is connected and set to the water mains). Pour 250 ml of descaling product into the water tank.

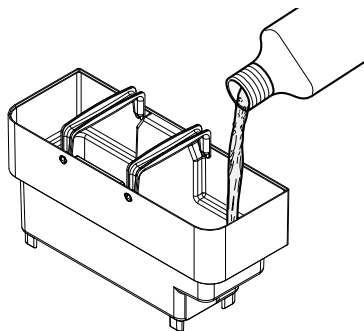
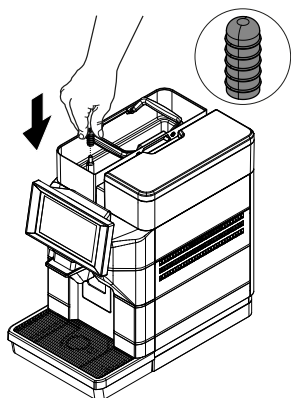

Add water into the water tank up to the "CALC CLEAN" level.

Remove the tank from the machine and empty it. lift it using the inside handles.

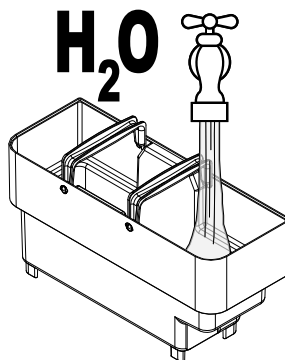
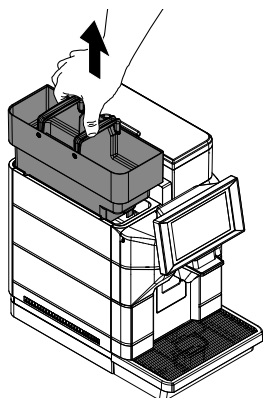

Put back the water tank.

Insert Cappuccinatore

Remove the anti-limescale filter from the water tank, if present. (Only if the appliance is not connected or set to the water mains).

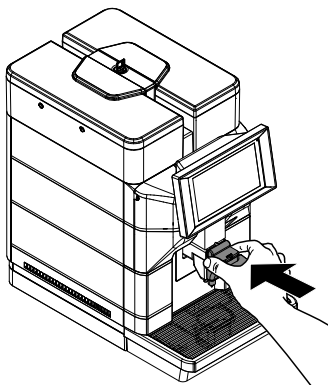
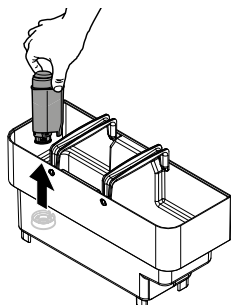

Insert the clean suction hose into an empty container of at least 250 ml.

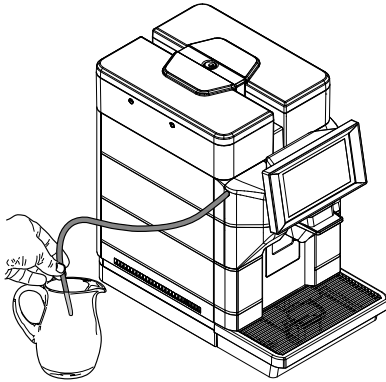

Remove and empty the drip tray.

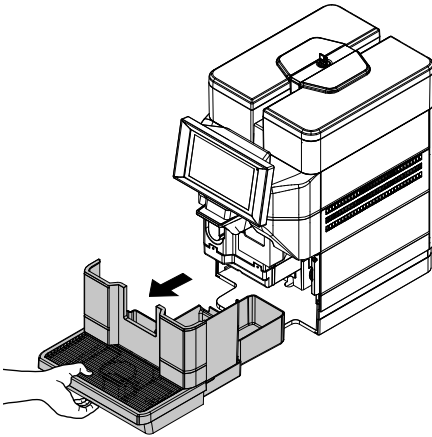

After emptying it put the drip tray back into place. Insert a large container under the dispensers.

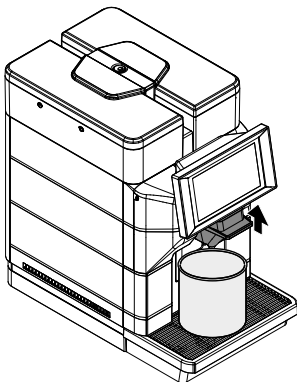

Run the first descaling phase. When the solution in the tank is finished, the machine requests to empty and rinse the tank with fresh drinking water. Rinse the water tank properly.

⚠ If the appliance is not connected or set to the water mains, fill the tank with fresh drinking water up to the MAX level and put it back into the machine.

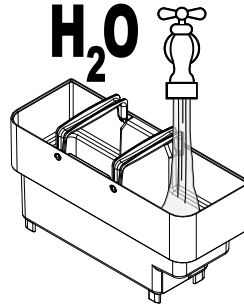

⚠ If the appliance is connected and set to the water mains, reinsert the empty tank into the machine.

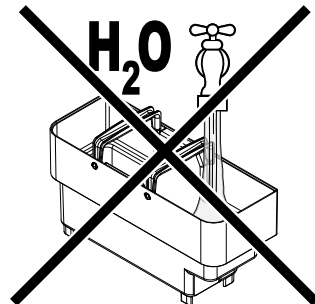

Remove the cap from the water tank. (Only if the appliance is connected and set to the water mains). Empty the container placed under the dispensers. Remove and empty the drip tray.

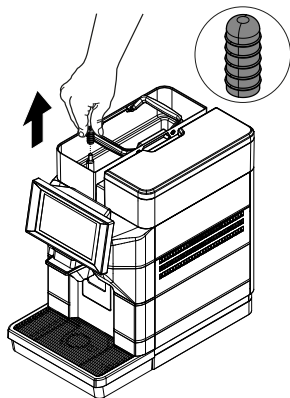

Insert Cappuccinatore

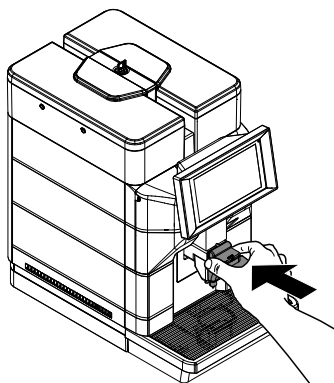

Insert the clean suction hose into an empty container of at least 250 ml.

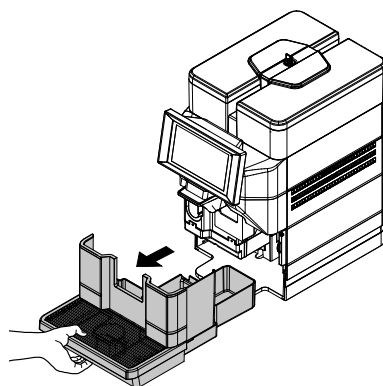
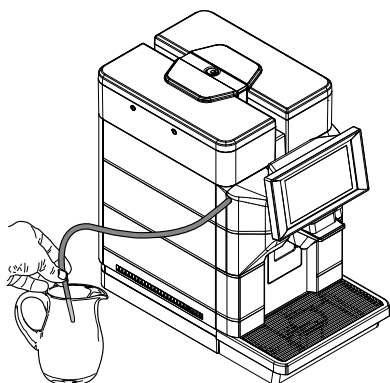

After emptying it put the drip tray back into place. Insert a large container under the dispensers.

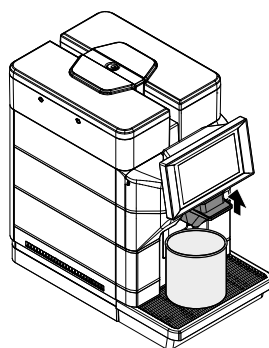

Run the second descaling phase, in other words rinse. Wait for the rinse cycle to be completed.

After completing the descaling cycle, empty the containers used to collect the liquids during descaling. The descaling solution must be disposed of as provided on the container and/or the regulations in force in the country of use. Empty the drip tray and place it back.

Re-insert the small white filter or water filter based on how you have chosen to proceed. Fill the water tank again up to the MAX level with fresh drinking water. (Only if the appliance is not connected or set to the water mains).

II TROUBLESHOOTING

II.1 Warning signals

This chapter describes all the warning messages that the machine may display to the user and the actions that can and/or must be performed by the user.

String	ID	Description
Drip tray full	1	Liquid container full
Coffee temperature not ready	45	The coffee heating unit is not ready to dispense
Waiting for milk rinsing	58	Waiting for the rinsing of the milk circuit
Water mains filling Timeout	64	Circuit recharge alarm or tank level control failure
Solid waste full	68	Residue container full
Solid waste not present	91	Residue container not present
Milk temperature not ready	95	The milk heating unit is not ready to dispense
Milk cleaning needed	101	The milk circuit needs to be washed
Water tank is empty	251	The water level in the tank is not sufficient
Water Filter must be changed	255	The water softeners must be replaced
Brewing unit missing	301	The coffee dispenser unit is missing
Circuit priming needed	303	The hydraulic circuit must be loaded
Cappuccino maker missing	304	Cappuccino maker missing
Door opened	316	Side door open
Out of coffee beans	317	Out of coffee beans
Descaling procedure must be completed	320	Descaling procedure must be completed
Descaling procedure needed	321	Descaling procedure needed
Milk rinsing needed	322	The milk circuit needs to be rinsed
Solid waste warning	323	Residue container almost full
Drip tray warning	324	Liquid container almost full
Water filter warning	326	Water softener almost spent



11.2 Problems - Causes - Solutions

The following table indicates the possible error or alarm causes which may lead to a partial or total shutdown of the appliance.

String	Error code	Description
Board communication error	E7	Communication error
No communication with the payment device	E88	The payment system is active, but there is no communication with the device.
GRINDER BLOCKED	E305	The coffee grinder is blocked and won't turn
Brewing unit can't reach WORK	E306	The unit can't reach the WORK position
Brewing unit can't reach HOME	E307	The unit can't reach the HOME position
Coffee water circuit clogged	E308	The flow meter is stopped, water does not flow even if the pump is on
DC valve failure	E309	One of the solenoid valves is not working
Doser failure	E310	If the microswitch of the doser is pressed (indicating doser full) and, when powering the doser it does not switch, an error is generated (after 4 attempts)
Coffee Heater temperature sensor short circuit	E311	Temperature sensor (NTC) short circuit
Coffee Heater temperature sensor open loop	E312	Temperature sensor (NTC) does not convey
Coffee Heating up timeout	E313	The heating unit did not reach the target within the maximum time
BREWING UNIT SHORT CIRCUIT	E314	Gear motor of the brewing unit has short circuited
Zero crossing failure	E315	The electricity grid is unstable
Milk Circuit clogged	E327	The flow meter is stopped, water does not flow even if the pump is on
Milk Heater temperature sensor short circuit	E328	Temperature sensor (NTC) short circuit
Milk Heater temperature sensor open loop	E329	Temperature sensor (NTC) does not convey
Milk Heating up timeout	E330	The heating unit did not reach the target within the maximum time
Heater coffee over temperature	E331	The heating unit temperature is too high
Heater milk over temperature	E332	The heating unit temperature is too high

Every time the machine reports one of these errors it tracks it at the same time in its error log.

 The occurrence of each of these errors causes all the charges to turn off instantaneously (gear motors, heating unit, pump, solenoid valves) and a monkey wrench appears on the screen with the relative identification number.



12 STORAGE - DISPOSAL

12.1 Location Change

Should the machine be placed in a different location, it is necessary to:

- disconnect the appliance from the supply network;
- carry out the general cleaning of the appliance as indicated in chapter "Cleaning and Maintenance";
- put the parts back into place and close the doors;
- Lift and position the appliance in the assigned location.

12.2 Inactivity and Storage

If the appliance needs to be stored or remains inactive for a long period, carry out the same operations as described in section "Location Change", therefore:

- wrap the appliance with a cloth to protect it from dust and humidity;
- make sure that the appliance is installed in a suitable place (temperature must be lower than 1°C) and be careful not to put cartons or appliances on it.

13 INSTRUCTIONS FOR END OF OPERATIONAL LIFE DISPOSAL



INFORMATION TO THE USER

pursuant to Art. 13 of Legislative Decree no. 151 of 25 July 2005 "And in compliance with the provisions of the RAEE Directive relative to the reduction of the use of hazardous substances in electric and electronic appliances, as well as the disposal of the waste".

The crossed-out wheeled bin icon on the appliance or its packaging indicates that the product must be disposed of separately from other waste at the end of its operational life.

Separate collection of the appliance at the end of its operational life is organised and managed by the manufacturer. Therefore, for an appropriate disposal, the user must contact the manufacturer and observe its separate collection management adopted for this appliance at the end of its operational life.

Separating this product for subsequent recycling, treatment and environmental-friendly disposal will help prevent potential environmental and health risks, and allow the materials which make up the appliance to be re-used and/or recycled.

Specific administrative sanctions provided for by current regulations will be applied for illicit disposal of the product by the user.

